

FLUKE®

**Process
Instruments**

ThermoView® TV40

Thermal imaging solutions for industrial applications



Integrate

Visualize

Control

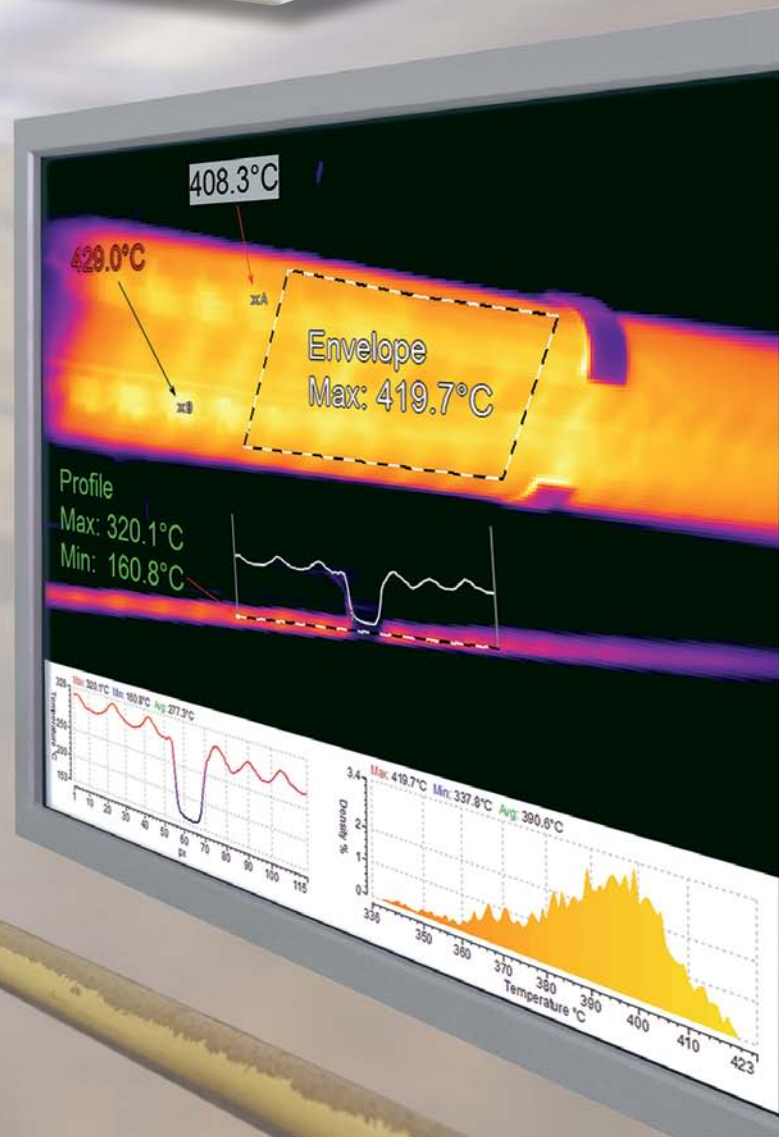

Max = 27.1

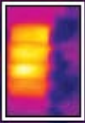

Best in Class from Fluke Process Instruments

The ThermoView TV40 is a high-performance industrial thermal imaging system designed for factory automation applications combining a rugged thermal imaging camera with intuitive and powerful control and monitoring software. The system provides a fully integrated solution for temperature control, monitoring and data archiving to ensure process traceability and product quality.

Thermal imaging solution that allows you to visualize and control your industrial process applications.

Integrate

GigE Vision, Power over Ethernet, along with digital and analog I/O modules allows for easy integration of the Thermal Imager TV40 into any plant level automation system. A unique IP67 rated housing, together with a wide range of accessories designed for your harshest industrial environment, guarantees reliable and long-term thermal imaging. Multiple pre-calibrated lenses are field interchangeable, ensuring the right field of view for any application, while the standard camera with integrated lens means there are no external moving parts. TV40 thermal imagers come with integrated visible light, allowing combined infrared and visible light viewing for remote verification of proper sighting. You can monitor your process with ThermoView software or by connecting directly to the web server integrated in the thermal imager.

Visualize

Stream thermal images at up to 60 frames per second with GigE Vision capability. Multiple software tools make it easy to analyze your temperature data post-process, giving you the ability to dig deeper than what might be practical in real time. TV40 thermal imagers provide high resolution infrared and visible images simultaneously to the ThermoView software for analysis of your process, highlighting details that may be overlooked otherwise. Stich together images and live views from multiple cameras to catch every detail.

Control

Combining TV40 thermal imagers and the ThermoView software allows for continuous monitoring and alarms when an unwanted temperature event occurs, using DAQ modules or EtherNet/IP for I/O process control. Manual or automated image and AOI data archiving provides process traceability. Monitor, archive, and alarm multiple imagers simultaneously using the ThermoView software.

TV 43

320 x 240
Thermal Imager +
Visible Light Camera

TV 46

640 x 480
Thermal Imager +
Visible Light Camera

8 - 14 μm spectral range

-10 to 1200 °C
(14 to 2192 °F)

Add on lens options (add in field)

0.75x wide angle (45° x 34°)
2x lens (17° x 12.7°)
4x lens (8.5° x 6°)
Macro lens

ThermoView software and TV40 thermal imagers provide process control, monitoring and archiving capabilities for industrial process applications.

With ThermoView software, you can interface to process control equipment via discreet I/O or EtherNet/IP receiving synchronization inputs and providing pass/fail logic outputs performing product inspections, temperature alarming and monitoring, and process temperature archiving. For product troubleshooting several temperature analysis and tools are available to provide trending.

TV40 thermal imagers offer a rugged product to the industrial applications which Fluke Process Instruments has served for many years. The thermal imager is housed in an IP67 enclosure using industrial sealed connectors. The standard thermal imager is offered with an "on-board" lens which means that there are no external moving parts. The thermal imager GigE high speed interface allows for high speed data transfer at 60 frames per second and also (PoE) Power over Ethernet.

Interface your TV40 thermal imager to ThermoView software which provides the following capabilities:

- Interface to ThermoView I/O
 - I/O alarming for over and under heating conditions
- Thermal imager recording and playback for offline data analysis
 - Saving of sequence files allows for process and product troubleshooting
- Usable in applications where multiple images need to be displayed and stitched together
- Multi-language selectable
- Multiple file export capabilities
- Trend data recording of AOI's (Areas of Interest)
 - Provides traceability to ensure product quality
- System alarming functions
- Support for multiple Windows operating systems (Windows 7, 8, 10)

Software

ThermoView Software

ThermoView software is a rich software package with a wide variety of analysis and process monitoring tools offered in a single package.

Analysis

- Histograms
- Isotherms
- Area and point trend data collection and display
- Simultaneously view off-line images while system continues to operate in automation mode

Automation mode

(for process monitoring, alarming, archiving)

- Continuous or intermittent inspection of temperature events
- User configurable setup up of temperature conditions to alarm or trigger events
- Establish alarms or signals that interface to discrete I/O and/or EtherNet/IP

General features

- Export of sequence files or trend data
- Independent emissivity for each AOI
- Multi-imager viewing

ThermoView Lite Software

ThermoView lite software provide a user with a startup software package to get familiar with the features and benefits of using the TV40 thermal imagers.

Benefits of the software include:

- Display thermal images from your TV40 thermal imager
- Load off-line images/sequences
- Copy images to clipboard

TV40 Thermal Imager Web Server

- Initial imager setup
- Display thermal and visible images from your TV40 thermal imager

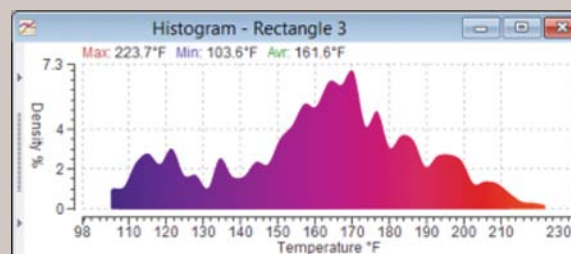
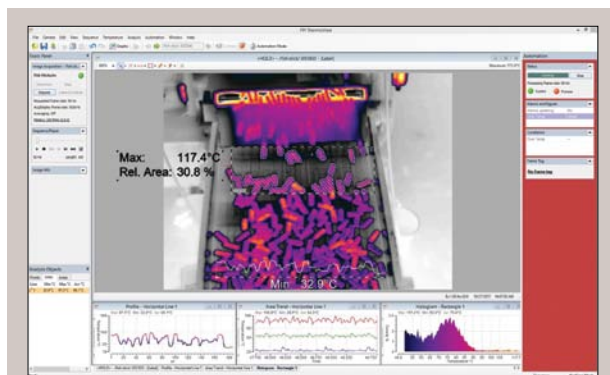

Histograms are helpful to show the distribution of temperatures over an area.

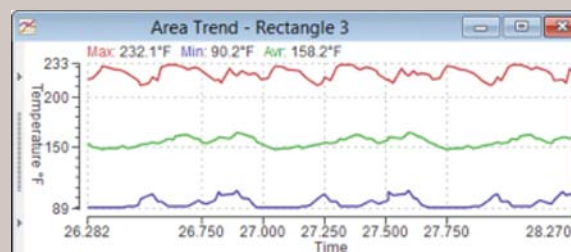

For each analysis object, you can plot the average, maximum, and minimum temperatures.

Key Features

- I/O alarming capabilities
- Communication to other devices through EtherNet/IP
- System health and automatic communication re-connection capabilities
- Recording of trend and sequence files for easy playback
- Simultaneous condition monitoring/alarming and offline viewing available
- Remote project loading from external devices for automation applications

Highlights

- Wide temperature range:
-10 to 1200 °C (14 to 2192 °F)
- 320 x 240 and 640 x 480 infrared resolution
- 9 or 60 Hz models available
- Rugged housing, IP67 (NEMA 4) rated
- Sighting: IR-Fusion® technology (thermal and visible sighting) for easy alignment and added detail on blended images
- Remote motorized focus
- Multiple field interchangeable lens options available
- GigE Vision interface
- LAN/Ethernet with PoE for communication with the thermal imager provides access to Ethernet, web server and ThermoView software
- ThermoView software for industrial automation applications
- Ambient temperatures to 200 °C (392 °F) with high temperature enclosure
- Air purge and accessories available

Accessories

A full range of mounting and enclosure accessories are available. In addition, you can use discrete I/O for triggering and alarm outputs.

Applications

- Temperature monitoring
- Critical asset monitoring
- Press hardening
- Brake testing
- Lime kiln shell
- Metal spin forming
- Waste incinerator
- Boiler monitoring

The Fluke Process Instruments Guarantee

The ThermoView TV40 thermal imager is supported by a 2 year warranty. With a network of trained representatives and agents in over one hundred countries and offices located in the U.S., Germany and China, we provide local service and support.

Fluke Process Instruments

Americas

Everett, WA USA
Tel: +1 800 227 8074 (USA and Canada, only)
+1 425 446 6300
solutions@flukeprocessinstruments.com

EMEA

Berlin, Germany
Tel: +49 30 4 78 00 80
info@flukeprocessinstruments.de

China

Beijing, China
Tel: +8610 6438 4691
info@flukeprocessinstruments.cn

Japan

Tokyo, Japan
Tel: +81 03 6714 3114
info@flukeprocessinstruments.jp

Asia East and South

India Tel: +91 22 62495028
Singapore Tel: +65 6799 5578
sales.asia@flukeprocessinstruments.com

Worldwide Service

Fluke Process Instruments offers services, including repair and calibration. For more information, contact your local office.

www.flukeprocessinstruments.com

© 2019 Fluke Process Instruments
Specifications subject to change without notice.
07/2019 6010792B

ThermoView® TV40

Thermal Imager Datasheet

Highlights

- Wide temperature range:
-10 to 1200 °C (14 to 2192 °F)
- 320 x240 and 640 x 480 infrared resolution
- 9 or 60 Hz models available
- Rugged housing, IP67 (NEMA 4) rated
- Sighting: IR-Fusion® technology (thermal and visible sighting) for easy alignment and added detail on blended images
- Remote motorized focus
- Multiple field interchangeable lens options available
- GigE Vision interface
- LAN/Ethernet with PoE for communication with the thermal imager provides access to Ethernet, Web server and ThermoView Software
- ThermoView software for industrial automation applications
- Ambient temperatures to 200 °C (392 °F) with high temperature enclosure
- Air purge and accessories available

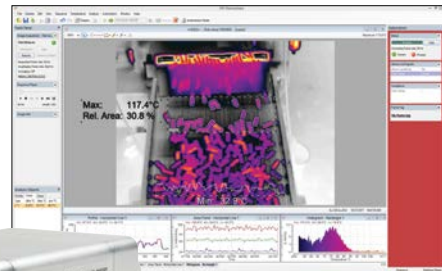

TV40 thermal imager with ThermoView software for factory automation, process inspection or process monitoring applications.

New to the world – a high performance industrial thermal imager from the brand you trust, backed by 150 years of industrial application experience. Designed for the most challenging environmental conditions you face, and supported by an intuitive and powerful analysis software, ThermoView TV40 provides the performance and personalization to meet your process monitoring and control needs.

Lens Field of View examples

Lens Type	Distance		HFOV		VFOV		Pixel Size	
	m	ft.	m	ft.	m	ft.	mm	in.
Standard Lens	0.5	1.6	0.3	1.0	0.2	0.8	0.93	0.037
	1.0	3.3	0.6	2.0	0.5	1.5	1.85	0.073
	3.0	9.8	1.8	6.0	1.4	4.5	5.56	0.219
	10.0	32.8	6.1	20.1	4.6	15.1	18.54	0.730
Wide Angle FPI 0.75X WIDE LENS	0.5	1.6	0.4	1.4	0.3	1.0	1.23	0.048
	1.0	3.3	0.8	2.7	0.6	2.0	2.45	0.097
	3.0	9.8	2.5	8.2	1.8	6.0	7.36	0.290
	10.0	32.8	8.3	27.2	6.1	20.1	24.54	0.966

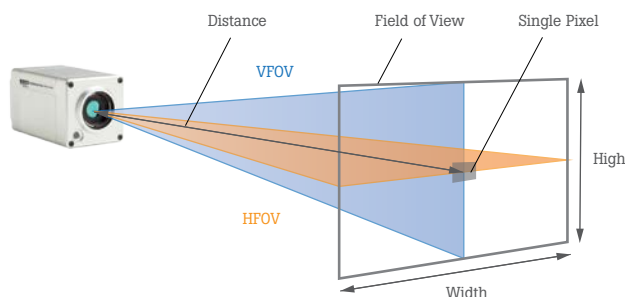

HFOV – Horizontal Field of View (horizontal aperture angle)
VFOV – Vertical Field of View (vertical aperture angle)

Measuring field sizes can be calculated online at:
www.flukeprocessinstruments.com/TV40

Measurement Specifications

	ThermoView TV43	ThermoView TV46
Sighting	Thermal Imager + Visible Light Camera (640 x 480)	
Measuring Range	-10 to 1200 °C (14 to 2192 °F)	
Measurement Accuracy	±2 °C or ±2 % (reading)	
Infrared Resolution	320 x 240 (76,800 pixels)	640 x 480 (307,200 pixels)
Spectral Range	8 - 14 μm	
Detector	Uncooled focal plane array	
Field of View	Horizontal 34° x 25.5°	
Add on Lens Options (add in field)	0.75x Wide lens (45° x 34°) 2x lens (17° x 12.7°) 4x lens (8.5° x 6°) Macro lens	
Focus Range	IR 15 cm – ∞ (motorized remote focus) Visible light: 60 cm – ∞	
Thermal Imager Frame Time	9 or 60 frames/sec. (must be specified at the time of ordering)	
Emissivity Correction	0.10 to 1.00	
Interface	GigE Vision	
LED Display	Power supply indication, system error codes	
Operating Temperature	-10 to 50 °C (14 to 122 °F)	
Storage Temperature	-20 to 50 °C (-4 to 122 °F)	
Humidity	10 – 95 % non-condensing	
Power Supply	DC + 12 to 26 V , PoE (Power over Ethernet)	
Power Consumption	8 W (typical) 13 W (maximum)	
Shock Resistance	IEC 60068-2-27 (mechanical shock): 50 g, 6 ms, 3 axis	
Vibration Resistance	IEC 60068-2-26 (sinusoidal vibration): 3 g, 11 – 200 Hz, 3 axis	
Environmental Protection	IP67 (NEMA 4)	
Dimensions (W x H x L)	Approximately 83 x 83 x 158 mm (3.25 x 3.25 x 6.22")	
Weight	Approximately 1.08 kg (2.38 lbs)	

Thermal Imager rear view



Thermal Imager front view

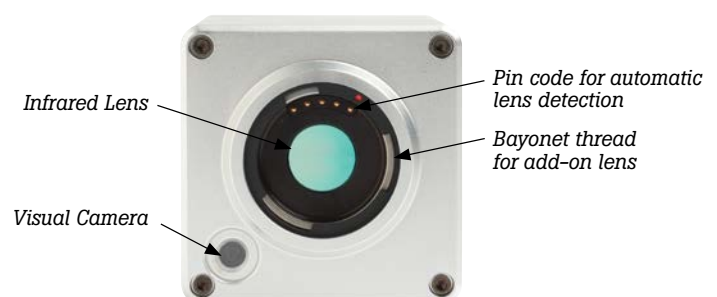

Thermal Imager Dimensions

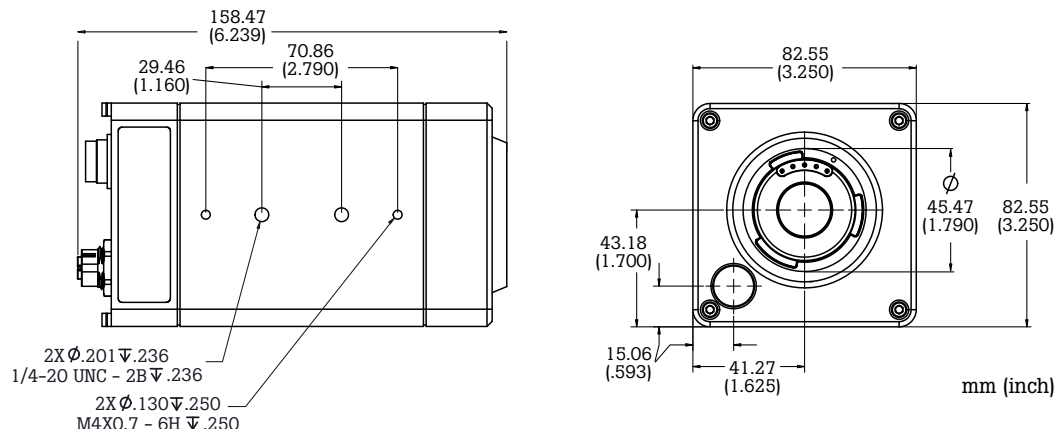

Accessories

TV40 thermal imagers are shipped with manual, calibration certification, quick reference guide, safety sheet.

Additional accessories include but are not limited to:

- Wide Angle for TV43/TV46 (45° x 34°)
(FPI 0.75X WIDE LENS)
- 2x telephoto for TV43/TV46 (17° x 12.7°)
(FPI 2X LENS)
- 4x telephoto for TV43/TV46 (8.5° x 6°)
(FPI 4X LENS)
- Macro Lens for TV43/TV46 **(FPI MACRO LENS)**
- PoE Injector (industrial duty) provides power and also acts as a single Ethernet hub (110/220 VAC input) **(A-TV-POE-2)**
- Air purge collar (includes protective window) **(A-TV-AP)**
- Protective enclosure (water cooled/air purged) **(A-TV-WC)**
- Protective Window - ThermoView **(A-TV-PW)**
- 24 VDC 1.2 A industrial power supply, DIN rail mount **(A-PS-DIN-24V)**
- Mounting Base **(A-TV-MB)**

The Fluke Process Instruments Guarantee

The ThermoView TV40 thermal imager is supported by a 2 year warranty. With a network of trained representatives and agents in over one hundred countries and offices located in the U.S., Germany and China, we provide local service and support.

Fluke Process Instruments

Americas

Everett, WA USA
Tel: +1 800 227 8074 (USA and Canada, only)
+1 425 446 6300
solutions@flukeprocessinstruments.com

EMEA

Berlin, Germany
Tel: +49 30 4 78 00 80
info@flukeprocessinstruments.de

China

Beijing, China
Tel: +8610 6438 4691
info@flukeprocessinstruments.cn

Japan

Tokyo, Japan
Tel: +81 03 6714 3114
info@flukeprocessinstruments.jp

Asia East and South

India Tel: +91 22 62495028
Singapore Tel: +65 6799 5578
sales.asia@flukeprocessinstruments.com

Worldwide Service

Fluke Process Instruments offers services, including repair and calibration. For more information, contact your local office.

www.flukeprocessinstruments.com

© 2019 Fluke Process Instruments
Specifications subject to change without notice.
6/2019 6010793A1