



HAM-LET HI-TECH COMPONENTS

ORBITAL WELD AND METAL GASKET
FACE SEAL FITTINGS



TECHNICAL INFORMATION

We specialize in the design and production of high-quality, specially manufactured valves and fittings for High-Purity and Ultra High-Purity applications.

A joint effort of our expert engineers and technicians resulted in the development of a complete line that reflects the company's deep understanding of the critical requirements of the semiconductor, biotech, and pharmaceutical industries.

We are a leader in the manufacture of fittings and valves for clean industries and consistently spearhead significant new developments in this field. **HTC** has broken new ground in surface finishing techniques by implementing improved electro-polishing processes.

PLATING

Female threads are silver plated in order to reduce the risk of galling and to improve the ability to reproduce the fitting. This high-quality plating also reduces the torque required for the fitting assembly.

Reference Spec: Meeting and exceeding - Mil Spec: QQ-S-365

Note: Do not apply any type of cleaning acid and/or electropolishing solutions to any female threads. These solutions damage the silver-plating and invalidate any expressed or implied warranty.

WELDING

Options: butt weld, shoulder weld, socket weld Reference Specs: All welded products are manufactured and welded according to SEMI F75,F81.

TESTING

UCT FS follows the relevant ASTM, ANSI, ASME, ISO, SEMI & SEMASPEC standards for testing and for qualifying processes and results.

JAPANESE STANDARDS

Upon request, UCT can manufacture HTC® product line to meet Japanese standards:

- Low manganese material specifications (JIS)
- Wall thickness
- Hardness

⁽¹⁾ Per SEMI F20-0305

TEMPERATURE RATING

Products	Material	°F	°C
HTC Face Seal Fittings	SST 316L	1000	538
	SST 316L Var or Vim / Var ⁽¹⁾	1000	538
HTC Welding Fittings	SST 316L	1000	538
	SST 316L Var or Vim/Var ⁽¹⁾	1000	538
HTC Gaskets	SST 316	1000	538
	NICKEL	1000	538

HELIUM LEAK

All UCT Face seal products are tested and qualified to a maximum leak rate of 4x10⁻⁹ std cm³/sec with silver-plating, and to a maximum leak rate of 4x10⁻¹¹ std cm³/sec with unplated gaskets.

SURFACE FINISH

Reference Spec: ANSI B46.1 and ISO 4288

SURFACE ANALYSIS

SEM/EDX/AES analysis is used to monitor surface defects per ASTM F1372 and ASTM F1375

MOISTURE ANALYSIS

Based on ASTM F1397

PARTICLE CONTRIBUTION TEST

Based on Semaspec 90120390 B

SURFACE CHEMISTRY

All UHP products are electropolished with a proprietary process for achieving and exceeding the semantic standards of surface cleanliness and anti-corrosion requirements. Parameters are measured by SEM, AUGER, ESCA.

Reference Spec: SEMI F19; E49.9; SEMASPEC 91060573A-STD

CLEANING SPECIFICATIONS

According to # H9800

Reference Spec: SEMI E49.3

MATERIAL TRACEABILITY

All HTC components are heat coded for full traceability

ASSEMBLY

According to SEMI E49.6.

ACCESSORIES

Grip Kit, Plastic Bead Protector.

PACKAGING:

Each "E" finished component is double-bagged to ensure component cleanliness and to protect it from environmental contamination. The inner bag is nylon 6 and vacuum sealed. The outer bag is polyethylene.

Reference Spec: SEMI E49.1

INTERNATIONAL CERTIFICATIONS

ISO 9001, Certified by S.I.I.

HTC FITTINGS

PRESSURE RATING

Products	Material	Size	Wall Thickness	Pressure Rating	
			mm	c	bar
HTC Fittings	316L or 316LV	1/8"	0.028	8550	590
		1/4"	0.035	5200	359
		3/8"	0.035	3350	231
		1/2"	0.049	3750	259
		3/4"	0.065	3350	231
		3/4"	0.049	2400	165
		1"	0.065	2400	165

*3/4" & 1" sizes are not standard, but can be manufactured upon request.

Pressure ratings are calculated in accordance with ANSI Code for Pressure Piping ASME-B31.1, for stainless steel fittings. All working pressures are at 4:1 safety factor. Pressure indicated in the catalog is at room temperature.

GLAND MAKE-UP

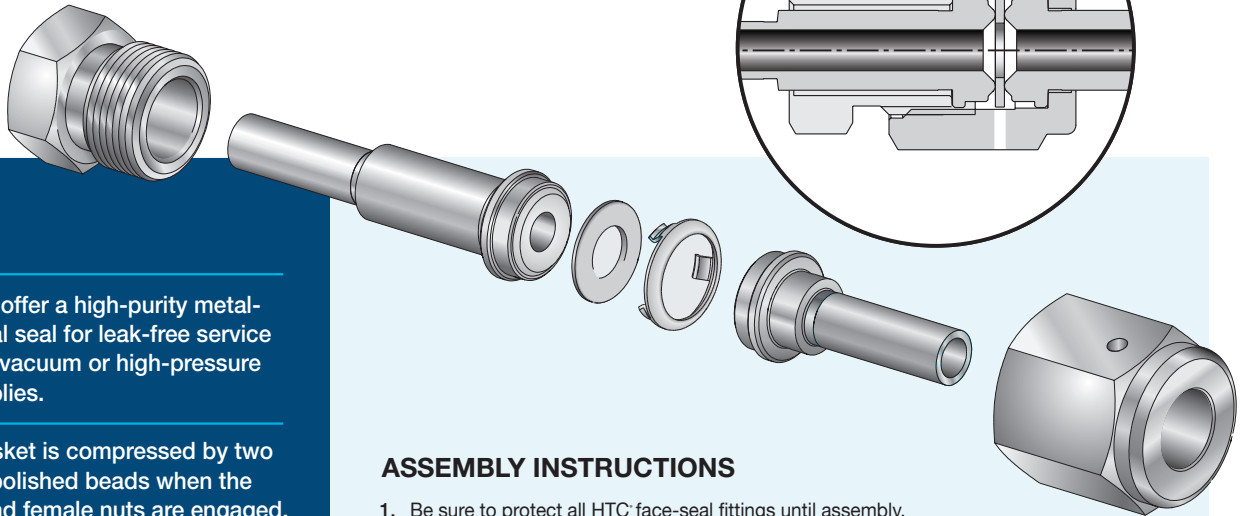

Glands offer a high-purity metal-to-metal seal for leak-free service in high-vacuum or high-pressure assemblies.

The gasket is compressed by two highly polished beads when the male and female nuts are engaged.

The gland bead to bead assembly compresses a soft-metal gasket-to-seal. This assembly can be locked by the HAM-LET Grip-Kit.

Visual test and leak testing are performed through two test ports in opposite locations from the female nut.

ASSEMBLY INSTRUCTIONS

1. Be sure to protect all HTC face-seal fittings until assembly. Exercise great care so that the sealing surfaces are not scratched, damaged or contaminated in any way during handling and assembly.
2. Always use a clean environment, and always employ proper cleanroom protocol for the make-up and assembly of high-purity fittings and applications.
3. **Make-up instructions:**
Hand-tighten the female nut to the male nut/body the finger tight. Tighten the female nut 1/8 turn past the finger tight point. Always torque the female nut while keeping the male nut/body stationary.
Face-seal connections are remakable - please use a new gasket for each remake.



MATERIALS

Products	Level "E"			Level "H"		
	Treatment	Ra (Microinch)		Treatment	Ra (Microinch)	
		Max	Average		Max	Average
Glands	Electropolished	10	5	Non-Electropolished	15	10
Mini butt weld	Electropolished	10	5	Non-Electropolished	15	10
Shaped unions	Electropolished	10	5	Non-Electropolished	20	15
Long weld shaped connectors	Electropolished	10	5	Non-Electropolished	15	10
Threaded straight connectors	Electropolished	10	5	Non-Electropolished	20	15

* "E" level - Electropolished ** "H" level - Not Electropolished

GLANDS

LONG GLAND

Without shoulder
GL-W



7

LONG GLAND

With shoulder
GL-S



7

MALE GLAND

Without shoulder
GM-W



8

SHORT GLAND

Without shoulder
GS-W



8

SHORT GLAND

With shoulder
GS-S



9

MINI SHORT GLAND

Without shoulder
MGS-W



9

MINI SHORT GLAND

With shoulder
MGS-S



10

GLAND ADAPTER TO LET-LOK[®]

AG



10

MALE GLAND

Short tube Without shoulder
MG-W



10

SOCKET WELD GLAND

GSW



11

SHAPED UNIONS

ELBOW UNION

EU



12

TEE UNION

TU



12

CROSS UNION

CU



12

MALE ELBOW

EM



13

THREADED STRAIGHT CONNECTORS

MALE UNION

UM



14

MALE REDUCING UNION

RUM



14

MALE TO MALE NPT CONNECTOR

CM



14

BULKHEAD UNION

BU



15

SHORT BULKHEAD UNION

SBU



15

MALE TO NPT BULKHEAD CONNECTOR

BCM



15

MALE TO SEAL O-RING CONNECTOR

CMOB



16

MALE TO FEMALE NPT CONNECTOR

FC



16

MALE TO LET-LOK UNION

UGL



16

MALE TO BULKHEAD LET-LOK UNION

BUL



17

MALE TO SHORT BULKHEAD LET-LOK UNION

SBUL



17

BULKHEAD TO TUBE UNION

Without shoulder
BHUT-W



17

SHORT BULKHEAD TO TUBE UNION

Without shoulder
SBHUT-W



18

CAPS, NUTS & PLUGS

COUPLING
CP



18

TAPERED MALE NUT
TNM



20

DOUBLE FEMALE UNION
DFU



18

SHORT MALE NUT
SNM



20

FEMALE NUT
NF



19

FEMALE CAP
CF



19

MALE PLUG
MP



19

MALE NUT
NM



20

SWIVEL CONNECTORS

FEMALE TO MALE UNION
UMF



21

FEMALE TO MALE NPT CONNECTOR
MCF



21

FEMALE TO FEMALE UNION
UFF



21

FEMALE TO FEMALE NPT CONNECTOR
FCF



22

FEMALE TO LET-LOK® CONNECTOR
FHTL



22

FEMALE CROSS UNION
CFFF



22

FEMALE TEE UNION
TFFF



23

FEMALE ELBOW UNION
EFF



23

HIGH-FLOW CONNECTORS

LONG HIGH-FLOW GLAND
HGL



24

HIGH-FLOW TO TUBE UNION
HMT



24

HIGH-FLOW FEMALE NUT
HNF



24

HIGH-FLOW MALE NUT
HNM



25

HIGH-FLOW ELBOW UNION
HEU



25

HIGH-FLOW TEE UNION
HTU



25

GASKETS

GASKET
GA



26

RETAINED GASKET
GA-RT



26

VERTICAL LOAD GASKET
GA-VL



27

MINI BUTTWELDS

MINI ELBOW

Without shoulder
ME-W



28

MINI ELBOW REDUCER

Without shoulder
MER-W



28

MINI ELBOW 45°

Without shoulder
ME-45°-W



29

MINI ELBOW

With extended leg
Without shoulder
MEX-W



29

MINI TEE

Without shoulder
MT-W



29

MINI TEE REDUCER

Without shoulder
MTR-W



30

MINI CROSS

Without shoulder
MC-W



30

MINI TRI-EL

Without shoulder
MTB-W



31

REDUCING UNION

Without shoulder
RU-W



31

LONG WELD CONNECTORS

ELBOW

Without shoulder
EW-W



32

TEE

Without shoulder
TW-W



32

TEE REDUCER

Without shoulder
TWR-W



33

CROSS

Without shoulder
CW-W



33

REDUCER

Without shoulder
RW-W



34

REDUCER BIG SIZE

Without shoulder
RW-W



34

BUTTWELD UNION

Without shoulder
UB-W



34

BUTTWELD UNION

With shoulder
UB-S



35

BUTTWELD UNION

With locator and shoulder
UBL-S



35

GRIPKIT

Fixes NUT



36

ORDERING INFORMATION:



Material Designator	
P	316L/316L VOD (AOD)
V	SST 316L Var or Vim/Var ⁽¹⁾
H	Alloy C-276
HC22	Alloy C-22
*NI	Nickel
*SS	Stainless Steel

Type of Fitting Designator
GL

Size Designator
1/8 6 mm
1/4 8 mm
3/8 10 mm
1/2 12 mm
3/4 18 mm
1 25 mm

End Designator	
S	With Shoulder
W	Without Shoulder

Surface Level Designator	
To indicate the desired level of polish, please add "E" or "H" to the part number:	
E	With Electropolish
H	Without Electropolish

* For gaskets only

⁽¹⁾Per SEMI F20-0305

GLANDS

GL-W

LONG GLAND

Without shoulder

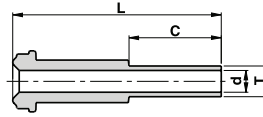

Ordering Information	Face Seal Size	L		C		d		T Tube O.D	W.T.	
		inch	mm	inch	mm	inch	mm		inch	mm
GL-1/8-W	1/8	36.1	1.42	19.1	0.75	1.90	0.07	1/8"	-	0.028
GL-1/4 X 1/8-W	1/4	36.1	1.42	19.1	0.75	1.90	0.07	1/8"	-	0.028
GL-1/4-W	1/4	43.2	1.70	19.1	0.75	4.60	0.18	1/4"	-	0.035
GL-3/8-W	1/2	45.5	1.79	19.1	0.75	7.70	0.30	3/8"	-	0.035
GL-1/2-W	1/2	45.5	1.79	19.1	0.75	10.2	0.40	1/2"	-	0.049
GL-1/2-W 1.41	1/2	35.8	1.41	9.6	0.38	10.2	0.40	1/2"	-	0.049
GL-1/2-W W.T.=0.065	1/2	45.5	1.79	19.1	0.75	9.50	0.37	1/2"	-	0.065
GL-1/2 X 1/4-W	1/2	45.5	1.79	19.1	0.75	4.60	0.18	1/4"	-	0.035
GL-3/4-W W.T.=0.049	3/4	51.6	2.03	19.1	0.75	16.6	0.65	3/4"	-	0.049
GL-3/4-W W.T.=0.065	3/4	51.6	2.03	19.1	0.75	15.8	0.62	3/4"	-	0.065
GL-1-W W.T.=0.065	1	58.9	2.32	19.1	0.75	22.1	0.87	1"	-	0.065
GL-6MM-W	1/4	43.2	1.70	19.1	0.75	4.00	0.16	6mm	1.00	-
GL-8MM-W	1/4	43.2	1.70	19.1	0.75	6.00	0.24	8mm	1.00	-
GL-10MM-W	1/2	45.5	1.79	19.1	0.75	8.00	0.31	10mm	1.00	-
GL-12MM-W	1/2	45.5	1.79	19.1	0.75	10.0	0.39	12mm	1.00	-
GL-18MM-W	3/4	51.6	2.03	19.1	0.75	15.0	0.59	18mm	1.50	-

GL-S

LONG GLAND

With shoulder

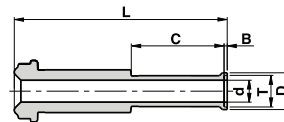

Ordering Information	Face Seal Size	L		C		d		B		D		T Tube O.D	W.T.	
		inch	mm	inch	mm	inch	mm	inch	mm	inch	mm		inch	
GL-1/4-S	1/4	43.7	1.72	19.1	0.75	4.6	0.18	0.6	0.02	7.4	0.29	1/4"	-	0.035
GL-3/8-S	1/2	46.2	1.82	19.1	0.75	7.7	0.30	0.8	0.03	10.4	0.41	3/8"	-	0.035
GL-1/2-S	1/2	46.5	1.83	19.1	0.75	10.2	0.40	1.0	0.04	14.0	0.55	1/2"	-	0.049
GL-1/2-S W.T.=0.065	1/2	46.5	1.83	19.1	0.75	9.5	0.37	1.0	0.04	14.0	0.55	1/2"	-	0.065
GL-3/4-S W.T.=0.049	3/4	52.6	2.07	19.1	0.75	16.6	0.65	1.0	0.04	20.3	0.80	3/4"	-	0.049
GL-3/4-S W.T.=0.065	3/4	52.6	2.07	19.1	0.75	15.8	0.62	1.0	0.04	20.3	0.80	3/4"	-	0.065
GL-1-S W.T.=0.065	1	65.3	2.57	19.1	0.75	22.1	0.87	1.0	0.04	26.9	1.06	1"	-	0.065
GL-6MM-S	1/4	43.7	1.72	19.1	0.75	4.0	0.16	0.5	0.02	7.0	0.27	6mm	1.00	-
GL-8MM-S	1/4	46.2	1.82	19.1	0.75	6.0	0.24	0.8	0.03	8.9	0.35	8mm	1.00	-
GL-10MM-S	1/2	46.2	1.82	19.1	0.75	8.0	0.31	0.8	0.03	10.9	0.43	10mm	1.00	-
GL-12MM-S	1/2	46.5	1.83	19.1	0.75	10.0	0.39	1.0	0.04	13.2	0.52	12mm	1.00	-
GL-18MM-S	3/4	52.6	2.07	19.1	0.75	15.0	0.59	1.0	0.04	19.3	0.76	18mm	1.50	-

Dimensions are for reference only and are subject to change without notice.

When ordering, be sure to add the Surface-Finish Designator (either H or E) to the part number.

**GM-W
MALE GLAND**

Without shoulder

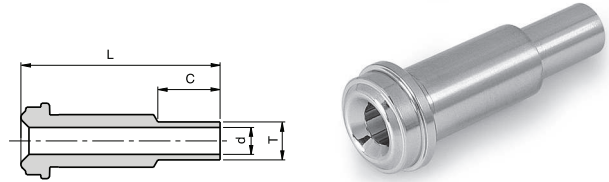

Ordering Information	Face Seal Size	L		C		d		T
	inch	mm	inch	mm	inch	mm	inch	Tube O.D
GM-1/8-W	1/8	17.8	0.70	7.10	0.28	1.90	0.07	1/8
GM-1/4-W	1/4	33.3	1.31	10.4	0.41	3.00	0.12	1/4
GM-3/8-W	1/2	38.1	1.50	10.4	0.41	7.10	0.28	3/8
GM-1/2-W	1/2	38.1	1.50	12.7	0.50	10.2	0.40	1/2
GM-3/4-W	3/4	50.8	2.00	15.7	0.62	13.5	0.53	3/4
GM-1-W	1	56.4	2.22	20.6	0.81	19.1	0.75	1

**GS-W
SHORT GLAND**

Without shoulder

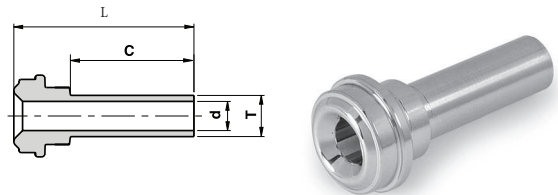

Ordering Information	Face Seal Size	L		C		d		T	W.T.	
	inch	mm	inch	mm	inch	mm	inch	inch/mm	mm	inch
GS-1/8-W	1/8	27.4	1.08	19.1	0.75	1.90	0.07	1/8"	-	0.028
GS-1/4-W	1/4	27.9	1.10	19.1	0.75	4.60	0.18	1/4"	-	0.035
GS-1/4 X 1/8 -W	1/4	27.9	1.10	19.1	0.75	1.90	0.07	1/8"	-	0.028
GS -1/4-W 0.72	1/4	18.3	0.72	9.6	0.38	4.60	0.18	1/4"	-	0.035
GS-3/8-W	1/2	28.4	1.12	19.1	0.75	7.70	0.30	3/8"	-	0.035
GS-1/2-W	1/2	28.4	1.12	19.1	0.75	10.2	0.40	1/2"	-	0.049
GS-1/2-W W.T.=0.065	1/2	28.4	1.12	19.1	0.75	9.50	0.37	1/2"	-	0.065
GS-1/2-W-0.74	1/2	18.8	0.74	9.7	0.38	10.2	0.40	1/2"	-	0.049
GS-1/2 X 1/4-W	1/2	28.4	1.12	19.1	0.75	4.60	0.18	1/4"	-	0.035
GS-3/4-W W.T.=0.049	3/4	29.0	1.14	19.1	0.75	16.6	0.65	3/4"	-	0.049
GS-3/4-W W.T.=0.065	3/4	29.0	1.14	19.1	0.75	15.8	0.62	3/4"	-	0.065
GS-1-W W.T.=0.065	1	32.0	1.26	19.1	0.75	22.1	0.87	1"	-	0.065
GS-6MM-W	1/4	29.4	1.16	19.1	0.75	4.00	0.16	6mm	1.00	-
GS-8MM-W	1/4	29.5	1.16	19.1	0.75	6.00	0.24	8mm	1.00	-
GS-10MM-W	1/2	29.4	1.16	19.1	0.75	8.00	0.31	10mm	1.00	-
GS-12MM-W	1/2	29.4	1.16	19.1	0.75	10.0	0.39	12mm	1.00	-
GS-18MM-W	3/4	31.0	1.22	19.1	0.75	15.0	0.59	18mm	1.50	-

Dimensions are for reference only and are subject to change without notice.
When ordering, be sure to add the Surface-Finish Designator (either H or E) to the part number.

GLANDS

GS-S

SHORT GLAND

With shoulder

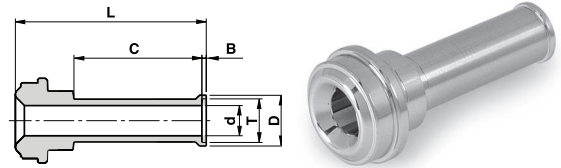

Ordering Information	Face Seal Size	L		C		d		B		D		T	W.T.	
	inch	mm	inch	mm	inch	mm	inch	mm	inch	mm	inch	inch/mm	mm	inch
GS-1/4-S	1/4	28.5	1.12	19.1	0.75	4.60	0.18	0.60	0.02	7.40	0.29	1/4"	-	0.035
GS-3/8-S	1/2	29.2	1.15	19.1	0.75	7.70	0.30	0.80	0.03	10.4	0.41	3/8"	-	0.035
GS-1/2-S	1/2	29.4	1.16	19.1	0.75	10.2	0.40	1.00	0.04	14.0	0.55	1/2"	-	0.049
GS-1/2-S W.T.=0.065	1/2	29.4	1.16	19.1	0.75	9.50	0.37	1.00	0.04	14.0	0.55	1/2"	-	0.065
GS-3/4-S W.T.=0.049	3/4	30.0	1.18	19.1	0.75	16.6	0.65	1.00	0.04	20.3	0.80	3/4"	-	0.049
GS-3/4-S W.T.=0.065	3/4	30.0	1.18	19.1	0.75	15.8	0.62	1.00	0.04	20.3	0.80	3/4"	-	0.065
GS-1-S W.T.=0.065	1	32.1	1.26	19.1	0.75	22.1	0.87	1.00	0.04	26.9	1.06	1"	-	0.065
GS-6MM-S	1/4	30.0	1.18	19.1	0.75	4.00	0.16	0.50	0.02	7.00	0.27	6mm	1.00	-
GS-8MM-S	1/4	30.2	1.19	19.1	0.75	6.00	0.24	0.80	0.03	8.90	0.35	8mm	1.00	-
GS-10MM-S	1/2	31.0	1.22	19.1	0.75	8.00	0.31	0.80	0.03	10.9	0.43	10mm	1.00	-
GS-12MM-S	1/2	30.5	1.20	19.1	0.75	10.0	0.39	1.00	0.04	13.2	0.52	12mm	1.00	-
GS-18MM-S	3/4	31.0	1.22	19.1	0.75	15.0	0.59	1.00	0.04	19.3	0.76	18mm	1.50	-

MGS-W

MINI SHORT GLAND

Without shoulder

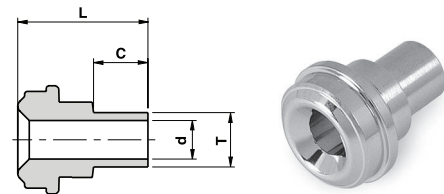

Ordering Information	Face Seal Size	L		C		d		T	W.T.	
	inch	mm	inch	mm	inch	mm	inch	inch / mm	mm	inch
MGS-1/4-W	1/4	15.2	0.60	6.40	0.25	4.60	0.18	1/4"	-	0.035
MGS-3/8-W	1/2	15.8	0.62	6.40	0.25	7.70	0.30	3/8"	-	0.035
MGS-1/2-W	1/2	15.8	0.62	6.40	0.25	10.2	0.40	1/2"	-	0.049
MGS-1/2-W W.T.=0.065	1/2	15.8	0.62	6.40	0.25	9.50	0.37	1/2"	-	0.065
MGS-6MM-W	1/4	15.2	0.60	6.40	0.25	4.00	0.16	6mm	1.00	-
MGS-8MM-W	1/4	15.8	0.62	6.40	0.25	6.00	0.24	8mm	1.00	-
MGS-10MM-W	1/2	15.8	0.62	6.40	0.25	8.00	0.31	10mm	1.00	-
MGS-12MM-W	1/2	15.8	0.62	6.40	0.25	10.0	0.39	12mm	1.00	-

Dimensions are for reference only and are subject to change without notice.
When ordering, be sure to add the Surface-Finish Designator (either H or E) to the part number.

GLANDS

MGS-S

MINI SHORT GLAND

With shoulder

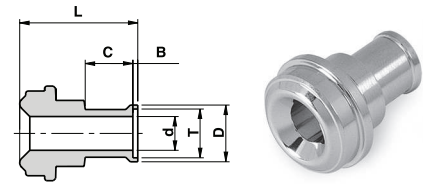

Ordering Information	Face Seal Size	L		C		d		B		D		T	W.T.	
	inch	mm	inch	mm	inch	mm	inch	mm	inch	mm	inch	inch/mm	mm	inch
MGS-1/4-S	1/4	15.8	0.62	6.4	0.25	4.60	0.18	0.6	0.02	7.40	0.29	1/4"	-	0.035
MGS-3/8-S	1/2	16.5	0.65	6.4	0.25	7.70	0.30	0.8	0.03	10.4	0.41	3/8"	-	0.035
MGS-1/2-S	1/2	16.8	0.66	6.4	0.25	10.2	0.40	1.0	0.04	14.0	0.55	1/2"	-	0.049
MGS-1/2-S W.T.=0.065	1/2	16.8	0.66	6.4	0.25	9.50	0.37	1.0	0.04	14.0	0.55	1/2"	-	0.065
MGS-6MM-S	1/4	15.8	0.62	6.4	0.25	4.00	0.16	0.5	0.02	7.00	0.27	6mm	1.00	-
MGS-8MM-S	1/4	16.5	0.65	6.4	0.25	6.00	0.24	0.8	0.03	8.90	0.35	8mm	1.00	-
MGS-10MM-S	1/2	16.5	0.65	6.4	0.25	8.00	0.31	0.8	0.03	10.9	0.43	10mm	1.00	-
MGS-12MM-S	1/2	16.8	0.66	6.4	0.25	10.0	0.39	1.0	0.04	13.2	0.52	12mm	1.00	-

AG

GLAND ADAPTER TO LET-LOK

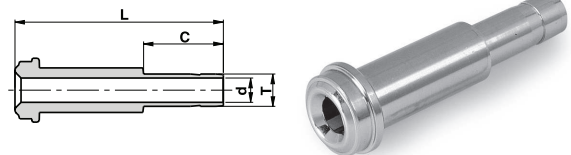

Ordering Information	Face Seal Size	L		C		d		T
	inch	mm	inch	mm	inch	mm	inch	inch/mm
AG-1/4	1/4	41.2	1.62	15.9	0.62	4.3	0.17	1/4"
AG-3/8	1/2	46.0	1.81	17.5	0.69	6.8	0.27	3/8"
AG-1/2	1/2	49.3	1.94	24.4	0.96	9.4	0.37	1/2"
AG-6M	1/4	41.2	1.62	15.7	0.62	4.0	0.16	6mm

MG-W

MALE GLAND

Short tube without shoulder

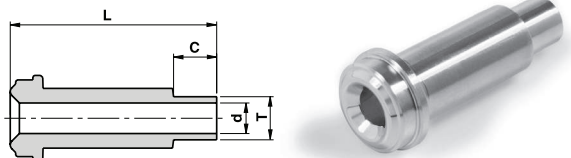

Ordering Information	Face Seal Size	L		C		d		T	W.T.	
	inch	mm	inch	mm	inch	mm	inch	inch/mm	mm	inch
MG-1/4-W	1/4	30.5	1.20	6.4	0.25	4.60	0.18	1/4"	-	0.035
MG-1/4-W 1.32	1/4	33.5	1.32	9.6	0.38	4.60	0.18	1/4"	-	0.035
MG-3/8-W	1/2	32.8	1.29	6.4	0.25	7.70	0.30	3/8"	-	0.035
MG-1/2-W	1/2	32.8	1.29	6.4	0.25	10.2	0.40	1/2"	-	0.049
MG-6MM-W	1/4	30.5	1.20	6.4	0.25	4.00	0.16	6mm	1.00	-
MG-8MM-W	1/4	30.5	1.20	6.4	0.25	6.00	0.24	8mm	1.00	-
MG-10MM-W	1/2	32.8	1.29	6.4	0.25	8.00	0.31	10mm	1.00	-
MG-12MM-W	1/2	32.8	1.29	6.4	0.25	10.0	0.39	12mm	1.00	-

Dimensions are for reference only and are subject to change without notice.

When ordering, be sure to add the Surface-Finish Designator (either H or E) to the part number.

GSW SOCKET WELD GLAND

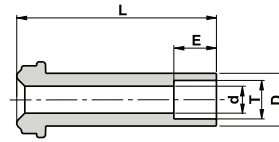

Ordering Information	Face Seal Size	L		d		E		D		T
	inch	mm	inch	mm	inch	mm	inch	mm	inch	Tube O.D
GSW-1/8	1/8	17.8	0.70	2.40	0.09	2.50	0.10	5.10	0.20	1/8
GSW-1/4	1/4	33.3	1.31	4.60	0.18	7.10	0.28	8.90	0.35	1/4
GSW-1/4-W-0.75"	1/4	19.1	0.75	4.60	0.18	7.10	0.28	8.90	0.35	1/4
GSW-1/4-W-0.50"	1/4	12.7	0.50	4.60	0.18	7.10	0.28	8.90	0.35	1/4
GSW-3/8	1/2	38.1	1.50	7.10	0.28	7.90	0.31	15.2	0.60	3/8
GSW-1/2	1/2	38.1	1.50	10.2	0.40	9.60	0.38	15.2	0.60	1/2
GSW-3/4	3/4	50.8	2.00	15.7	0.62	11.2	0.44	22.4	0.88	3/4
GSW-1	1	56.4	2.22	22.1	0.87	15.7	0.62	30.2	1.19	1

Dimensions are for reference only and are subject to change without notice.
When ordering, be sure to add the Surface-Finish Designator (either H or E) to the Part Number.

SHAPED UNIONS

EU ELBOW UNION

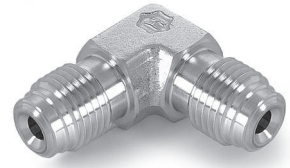
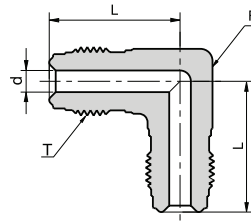

Ordering Information	Face Seal Size	L		d		F	T
	inch	mm	inch	mm	inch	inch	inch
P-EU-1/4	1/4	27.2	1.07	4.60	0.18	1/2	9/16-18
P-EU-1/2	1/2	36.8	1.45	10.2	0.40	13/16	7/8-14
P-EU-3/4	3/4	48.8	1.92	15.8	0.62	1 1/4	1 1/4 -18
P-EU-1	1	50.8	2.00	22.1	0.87	1 11/16	1 1/2 -20

TU TEE UNION

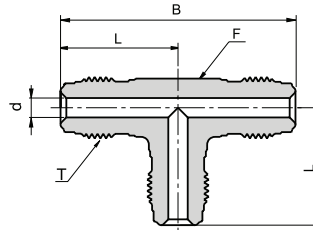

Ordering Information	Face Seal Size	L		B		d		F	T
	inch	mm	inch	mm	inch	mm	inch	inch	inch
P-TU-1/4	1/4	27.2	1.07	54.4	2.14	4.60	0.18	1/2	9/16-18
P-TU-1/2	1/2	36.8	1.45	73.6	2.90	10.2	0.40	13/16	7/8-14
P-TU-3/4	3/4	48.8	1.92	97.6	3.84	15.8	0.62	1 1/4	1 1/4 -18
P-TU-1	1	50.8	2.00	101.6	4.00	22.1	0.87	1 11/16	1 1/2 -20

CU CROSS UNION

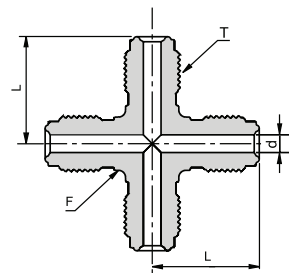

Ordering Information	Face Seal Size	L		d		F	T
	inch	mm	inch	mm	inch	inch	inch
P-CU-1/4	1/4	27.2	1.07	4.60	0.18	1/2	9/16-18
P-CU-1/2	1/2	36.8	1.45	10.2	0.40	13/16	7/8-14

Dimensions are for reference only and are subject to change without notice.
When ordering, be sure to add the Surface-Finish Designator (either H or E) to the part number.

SHAPED UNIONS

EM MALE ELBOW

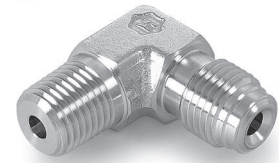
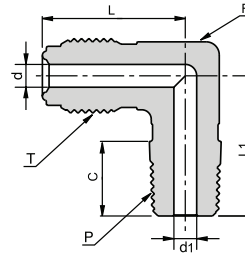

Ordering Information	Face Seal Size	L		L1		C		d		d1		F	T Thread Size	P NPT-M
	inch	mm	inch	mm	inch	mm	inch	mm	inch	mm	inch	inch	inch	inch
P-EM-1/4 X 1/8	1/4	27.2	1.07	22.1	0.87	9.60	0.38	4.60	0.18	4.60	0.18	1/2	9/16-18	1/8
P-EM-1/4 X 1/4	1/4	27.2	1.07	26.7	1.05	14.2	0.56	4.60	0.18	4.60	0.18	1/2	9/16-18	1/4
P-EM-1/4 X 1/2	1/4	31.2	1.45	33.5	1.26	19.0	0.75	4.60	0.18	9.50	0.37	13/16	9/16-18	1/2
P-EM-1/2 X 1/4	1/2	36.8	1.23	32.0	1.32	14.2	0.56	10.2	0.40	4.60	0.18	13/16	7/8-14	1/4
P-EM-1/2 X 3/8	1/2	36.8	1.45	32.0	1.26	14.2	0.56	10.2	0.40	9.50	0.37	13/16	7/8-14	3/8
P-EM-1/2 X 1/2	1/2	36.8	1.45	36.8	1.45	19.0	0.75	10.2	0.40	10.2	0.40	13/16	7/8-14	1/2

Dimensions are for reference only and are subject to change without notice.
When ordering, be sure to add the Surface-Finish Designator (either H or E) to the part number.

THREADED STRAIGHT CONNECTORS

UM MALE UNION

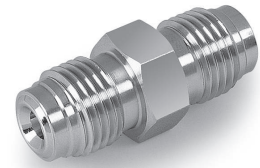
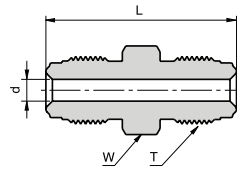

Ordering Information	Face Seal Size	L		d		W	T
	inch	mm	inch	mm	inch	inch	inch
P-UM 1/4	1/4	39.4	1.55	4.60	0.18	5/8	9/16 - 18
P-UM 1/2	1/2	46.7	1.84	10.2	0.40	15/16	7/8 - 14
P-UM 3/4	3/4	62.0	2.44	15.8	0.62	1 5/16	1 1/4 - 18
P-UM 1	1	65.8	2.59	22.2	0.87	1 5/8	1 1/2 - 20

RUM MALE REDUCING UNION

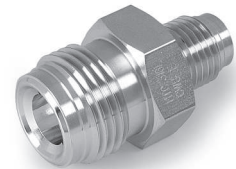
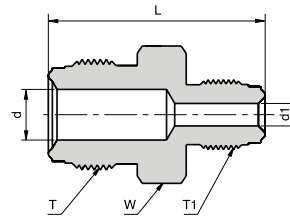

Ordering Information	Face Seal Size	Face Seal Size 1	L		d		d1		W	T	T1
	inch	inch	mm	inch	mm	inch	mm	inch	inch	inch	inch
P-RUM 1/4 X 1/8	1/4	1/8	34.8	1.37	4.60	0.18	2.4	0.09	5/8	9/16-18	5/16-24
P-RUM 1/2 X 1/4	1/2	1/4	43.4	1.71	10.2	0.40	4.6	0.18	15/16	7/8-1/4	9/16 -18

CM MALE TO MALE NPT CONNECTOR

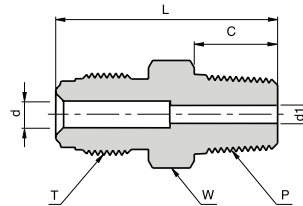

Ordering Information	Face Seal Size	L		C		d		d1		W	T	P
	inch	mm	inch	mm	inch	mm	inch	mm	inch	inch	inch	inch
P-CM-1/4 X 1/8	1/4	33.3	1.31	9.6	0.38	4.60	0.18	4.60	0.18	5/8	9/16 - 18	1/8
P-CM-1/4 X 1/4	1/4	37.8	1.49	14.2	0.56	4.60	0.18	4.60	0.18	5/8	9/16 - 18	1/4
P-CM-1/4 X R1/4 BSPT	1/4	37.8	1.49	14.2	0.56	4.60	0.18	4.60	0.18	5/8	9/16 - 18	1/4 BSPT
P-CM-1/2 X 1/4	1/2	41.9	1.65	14.2	0.56	10.2	0.40	7.10	0.28	15/16	7/8 - 14	1/4
P-CM-1/2 X 3/8	1/2	41.9	1.65	14.2	0.56	9.60	0.38	9.60	0.38	15/16	7/8 - 14	3/8
P-CM-1/2 X 1/2	1/2	46.7	1.84	19.0	0.75	10.2	0.40	10.2	0.40	15/16	7/8 - 14	1/2
P-CM-3/4 X 3/4	3/4	55.6	2.19	19.0	0.75	15.8	0.62	15.8	0.62	1 5/16	1 1/4 - 18	3/4
P-CM-1 X 1	1	62.7	2.47	23.9	0.94	22.2	0.87	22.2	0.87	1 5/8	1 1/2 - 20	1

Dimensions are for reference only and are subject to change without notice.
When ordering, be sure to add the Surface-Finish Designator (either H or E) to the part number.

THREADED STRAIGHT CONNECTORS

BU BULKHEAD UNION

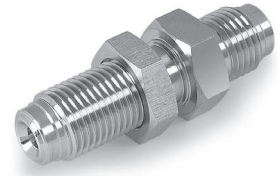
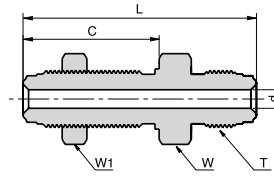

Ordering Information	Face Seal Size	L		C		d		W	W1	T	Panel Hole
	inch	mm	inch	mm	inch	mm	inch	inch	inch	inch	inch
P-BU 1/4	1/4	56.6	2.23	33.0	1.30	4.60	0.18	3/4	3/4	9/16 -18	19/32
P-BU 1/2	1/2	65.3	2.57	37.6	1.48	10.2	0.40	1 1/16	1 1/16	7/8 -14	29/32

SBU SHORT BULKHEAD UNION

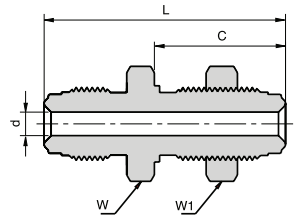

Ordering Information	Face Seal Size	L		C		d		W	W1	T	Panel Hole
	inch	inch	mm	inch	mm	inch	mm	inch	inch	inch	inch
P-SBU 1/4	1/4	46.2	1.82	25.1	0.99	4.60	0.18	3/4	3/4	9/16-18	19/32
P-SBU 1/2	1/2	54.4	2.14	28.2	1.11	10.2	0.40	1 1/16	1 1/16	7/8-14	29/32

BCM MALE TO NPT BULKHEAD CONNECTOR

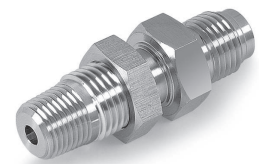
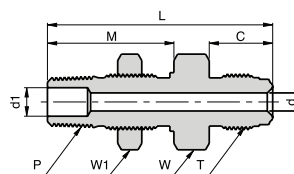

Ordering Information	Face Seal Size	L		C		d		M	d1	W	W1	T	P	Panel Hole		
	inch	mm	inch	mm	inch	mm	inch	mm	inch	mm	inch	inch	inch	inch		
P-BCM 1/4 X 1/4	1/4	56.1	2.21	15.8	0.62	4.60	0.18	31.5	1.24	7.1	0.28	13/16	13/16	9/16 -18	1/4	21/32
P-BCM 1/2 X 1/4	1/2	59.4	2.34	17.8	0.70	10.2	0.40	31.5	1.24	7.1	0.28	15/16	13/16	7/8 -14	1/4	21/32

Dimensions are for reference only and are subject to change without notice.
When ordering, be sure to add the Surface-Finish Designator (either H or E) to the part number.

THREADED STRAIGHT CONNECTORS

CMOB

MALE TO SEAL O-RING CONNECTOR

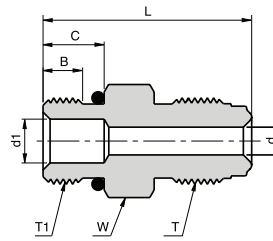

Ordering Information	Face Seal Size	L		C		B		d		d1		W	T	T1	O-Ring Size
	inch	mm	inch	mm	inch	mm	inch	mm	inch	mm	inch	inch	inch	inch	
P-CMOB 1/4 X 9/16	1/4	33.8	1.33	9.9	0.39	6.40	0.25	4.6	0.18	7.10	0.28	3/4	9/16 -18	9/16 -18	3-906
P-CMOB 1/2 X 7/8	1/2	42.2	1.66	12.7	0.50	10.2	0.40	7.1	0.28	15.0	0.59	1	7/8 -14	7/8 -14	3-910
P-CMOB 1/2 X 9/16	1/2	37.6	1.48	9.9	0.39	6.40	0.25	7.1	0.28	7.10	0.28	15/16	7/8 -14	9/16 -18	3-906

FC

MALE TO FEMALE NPT CONNECTOR

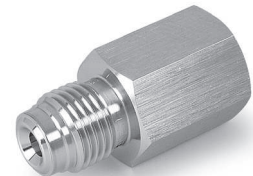
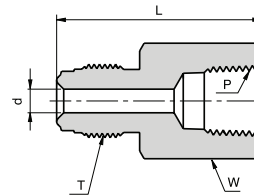

Ordering Information	Face Seal Size	L		d		W	T	P
	inch	mm	inch	mm	inch	inch	inch	inch
P-FC 1/4 X 1/8	1/4	35.8	1.41	4.60	0.18	5/8	9/16 -18	1/8
P-FC 1/4 X 1/4	1/4	39.1	1.54	4.60	0.18	3/4	9/16 -18	1/4
P-FC 1/2 X 1/4	1/2	39.1	1.54	10.2	0.40	15/16	7/8 -14	1/4
P-FC 1/2 X 3/8	1/2	44.7	1.76	10.2	0.40	15/16	7/8 -14	3/8
P-FC 1/2 X 1/2	1/2	50.5	1.99	10.2	0.40	1 1/16	7/8 -14	1/2
P-FC 3/4 X 3/4	3/4	59.9	2.36	15.8	0.62	1 5/16	1 1/4 -18	3/4
P-FC 1 X 1	1	63.8	2.51	22.1	0.87	1 5/8	1 1/2 -20	1

UGL

MALE TO LET-LOK UNION

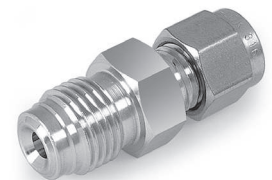
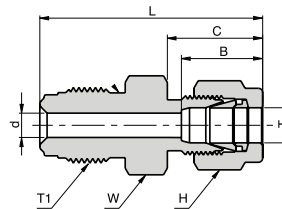

Ordering Information	Face Seal Size	L		C		B		d		W	H	T	T1
	inch	mm	inch	mm	inch	mm	inch	mm	inch	inch	inch	inch	inch
P-UGL 1/4 X 1/8	1/4	38.9	1.53	15.2	0.60	12.7	0.50	4.60	0.18	5/8	7/16	1/8	9/16 - 18
P-UGL 1/4 X 1/4	1/4	41.1	1.62	17.8	0.70	15.2	0.60	4.60	0.18	5/8	9/16	1/4	9/16 - 18
P-UGL 1/4 X 3/8	1/4	42.1	1.66	19.4	0.76	16.8	0.66	4.60	0.18	5/8	11/16	3/8	9/16 - 18
P-UGL 1/2 X 3/8	1/2	46.7	1.84	19.4	0.76	16.8	0.66	7.10	0.28	15/16	11/16	3/8	7/8 - 14
P-UGL 1/2 X 1/2	1/2	49.5	1.95	21.8	0.86	22.9	0.90	10.2	0.40	15/16	7/8	1/2	7/8 - 14

Dimensions are for reference only and are subject to change without notice.
When ordering, be sure to add the Surface-Finish Designator (either H or E) to the part number.

THREADED STRAIGHT CONNECTORS

BUL MALE TO BULKHEAD LET-LOK UNION

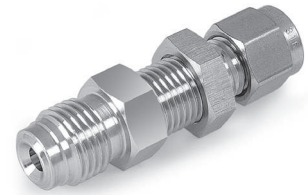
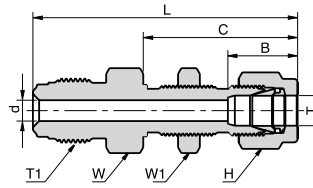

Ordering Information	Face Seal Size	L		C		B		d		W	W1	H	T	T1	Panel Hole Drill Size
	inch	mm	inch	mm	inch	mm	inch	mm	inch	inch	inch	inch	inch	inch	inch
P-BUL 1/4 X 1/4	1/4	57.2	2.25	33.5	1.32	15.2	0.60	4.60	0.18	5/8	5/8	9/16	1/4	9/16 - 18	29/64
P-BUL 1/2 X 3/8	1/4	64.5	2.54	36.8	1.45	16.8	0.66	7.10	0.28	15/16	3/4	11/16	3/8	7/8 - 14	37/64
P-BUL 1/2 X 1/2	1/2	69.9	2.74	41.9	1.65	22.9	0.90	10.2	0.40	15/16	15/16	7/8	1/2	7/8 - 14	49/64

SBUL MALE TO SHORT BULKHEAD LET-LOK UNION

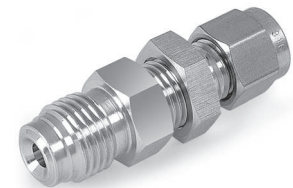
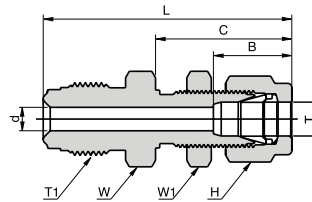

Ordering Information	Face Seal Size	L		C		B		d		W	W1	H	T	T1	Panel Hole Drill Size
	inch	mm	inch	mm	inch	mm	inch	mm	inch	inch	inch	inch	inch	inch	inch
P-SBUL 1/4 X 1/4	1/4	47.8	1.88	26.7	1.05	15.2	0.60	4.6	0.18	5/8	5/8	9/16	1/4	9/16-18	29/64

BHUT-W BULKHEAD TO TUBE UNION

Without shoulder

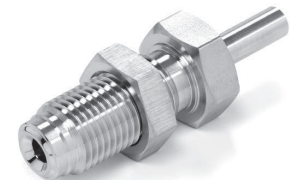
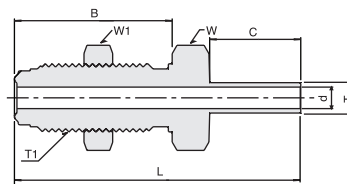

Ordering Information	Face Seal Size	L		B		C		d		W	W1	T	T1	Panel Hole Drill Size
	inch	mm	inch	mm	inch	mm	inch	mm	inch	inch	inch	inch	inch	inch
P-BHUT- 1/4 X 1/4-W	1/4	59.9	2.36	33.0	1.30	19.1	0.75	4.60	0.18	3/4	3/4	1/4	9/16 - 18	19/32
P-BHUT- 1/2 X 1/2-W	1/2	66.6	2.62	37.6	1.48	19.1	0.75	10.2	0.40	1 1/16	1 1/16	1/2	7/8 - 14	29/32

Dimensions are for reference only and are subject to change without notice.
When ordering, be sure to add the Surface-Finish Designator (either H or E) to the part number.

THREADED STRAIGHT CONNECTORS

SBHUT-W SHORT BULKHEAD TO TUBE UNION

Without shoulder

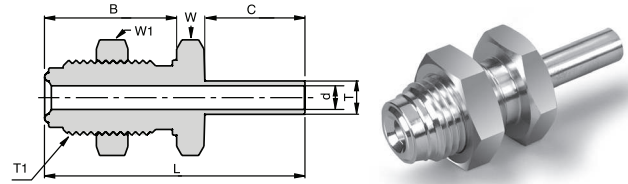

Ordering Information	Face Seal Size	L		B		C		d		W	W1	T	T1	Panel Hole Drill Size
	inch	mm	inch	mm	inch	mm	inch	mm	inch	inch	inch	inch	inch	inch
P-SBHUT- 1/4 X 1/4-W	1/4	49.5	1.95	25.1	0.99	19.1	0.75	4.60	0.18	3/4	3/4	1/4	9/16 - 18	19/32
P-SBHUT- 1/2 X 1/2-W	1/2	58.7	2.31	29.7	1.17	19.1	0.75	10.2	0.40	1 1/16	1 1/16	1/2	7/8 - 14	29/32

CAPS, NUTS & PLUGS

CP COUPLING

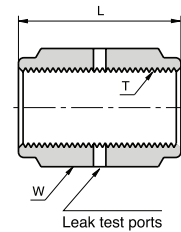

Ordering Information	Face Seal Size	L		W	T
	inch	mm	inch	inch	inch
P-CP 1/4	1/4	30.2	1.19	3/4	9/16 -18
P-CP 1/2	1/2	33.3	1.31	1 1/16	7/8 -14
P-CP 3/4	3/4	42.7	1.68	1 1/2	1 1/4 -18
P-CP 1	1	51.8	2.04	1 3/4	1 1/2 -20

DFU DOUBLE FEMALE UNION

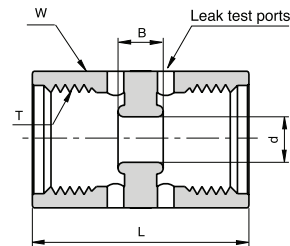

Ordering Information	Face Seal Size	L		B		d		W	T
	inch	mm	inch	mm	inch	mm	inch	inch	inch
P-DFU-1/4	1/4	30.2	1.19	6.0	0.24	6.40	0.25	3/4	9/16 - 18
P-DFU-1/2	1/2	33.3	1.31	6.0	0.24	14.0	0.55	1 1/16	7/8 - 14

Caution: This fitting should be used with a swivel male connector only.

Dimensions are for reference only and are subject to change without notice.

When ordering, be sure to add the Surface-Finish Designator (either H or E) to the part number.

**NF
FEMALE NUT**

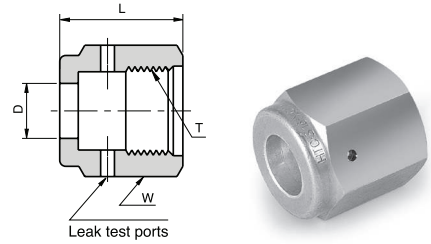

Ordering Information	Face Seal Size	L		D		W	T
	inch	mm	inch	mm	inch	inch	inch
P-NF 1/8	1/8	13.6	0.54	5.30	0.21	7/16	5/16-24
P-NF 1/4	1/4	20.6	0.81	9.20	0.36	3/4	9/16-18
P-NF 1/2	1/2	22.5	0.88	15.5	0.61	1 1/16	7/8-14
P-NF 3/4	3/4	28.5	1.12	22.6	0.89	1 1/2	1 1/4-18
P-NF 1	1	34.0	1.34	30.6	1.20	1 3/4	1 1/2-20

**CF
FEMALE CAP**

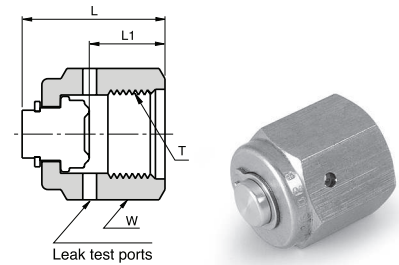

Ordering Information	Face Seal Size	L		L1		W	T
	inch	mm	inch	mm	inch	inch	inch
PCF1/8	1/8	16.6	0.65	8.40	0.33	7/16	5/16-24
P-CF 1/4	1/4	23.9	0.94	12.7	0.50	3/4	9/16-18
P-CF 1/2	1/2	25.6	1.01	14.2	0.56	1 1/16	7/8-14
P-CF 3/4	3/4	32.3	1.27	19.1	0.75	1 1/2	1 1/4-18
P-CF 1	1	39.0	1.53	23.4	0.92	1 3/4	1 1/2-20

**MP
MALE PLUG**

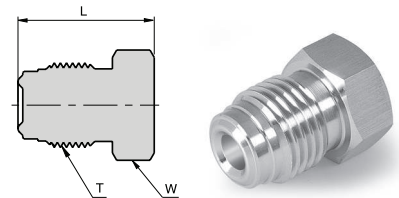

Ordering Information	Face Seal Size	L		W	T
	inch	mm	inch	inch	inch
P-MP 1/8	1/8	17.3	0.68	3/8	5/16 - 24
P-MP 1/4	1/4	23.4	0.92	5/8	9/16 - 18
P-MP 1/2	1/2	27.4	1.08	15/16	7/8 - 14
P-MP 3/4	3/4	36.3	1.43	1 5/16	1 1/4 - 18
P-MP 1	1	38.6	1.52	1 5/8	1 1/2 - 20

Dimensions are for reference only and are subject to change without notice.
When ordering, be sure to add the Surface-Finish Designator (either H or E) to the part number.

**NM
MALE NUT**

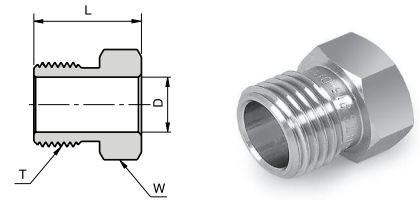

Ordering Information	Face Seal Size	L		D		W	T
	inch	mm	inch	mm	inch	inch	inch
P-NM 1/8	1/8	12.7	0.50	5.30	0.21	3/8	5/16-24
P-NM 1/4	1/4	18.0	0.71	9.20	0.36	5/8	9/16-18
P-NM 1/2	1/2	20.6	0.81	15.5	0.61	15/16	7/8-14
P-NM 3/4	3/4	25.4	1.00	22.7	0.89	1 5/16	1 1/4-18
P-NM 1	1	30.2	1.19	30.5	1.20	1 5/8	1 1/2-20

**TNM
TAPERED MALE NUT**

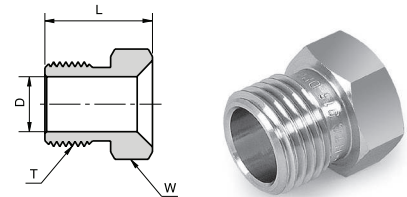

Ordering Information	Face Seal Size	L		D		W	T
	inch	mm	inch	mm	inch	inch	inch
P-TNM 1/4	1/4	18.0	0.71	9.20	0.36	5/8	9/16-18

**SNM
SHORT MALE NUT**

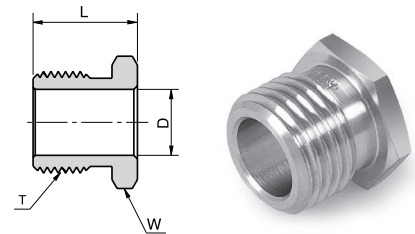

Ordering Information	Face Seal Size	L		D		W	T
	inch	mm	inch	mm	inch	inch	inch
P-SNM 1/4 .54	1/4	13.7	0.54	9.20	0.36	5/8	9/16-18
P-SNM 1/4 .65	1/4	16.5	0.65	9.20	0.36	5/8	9/16-18

Dimensions are for reference only and are subject to change without notice.
When ordering, be sure to add the Surface-Finish Designator (either H or E) to the part number.

SWIVEL CONNECTORS

UMF FEMALE TO MALE UNION

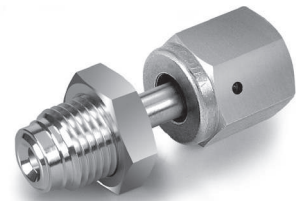
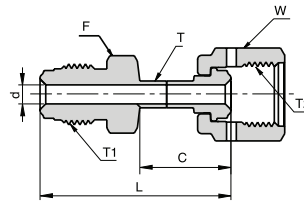

Ordering Information	Face Seal Size	L		C		d		F	W	T Tube O.D.	T1 Thread Size	T2 Thread Size
	inch	mm	inch	mm	inch	mm	inch	inch	inch	inch	inch	inch
P-UMF-1/4 X 1/4	1/4	45.2	1.78	21.6	0.85	4.60	0.18	5/8	3/4	1/4	9/16 - 18	9/16 - 18
P-UMF-1/2 X 1/2	1/2	49.8	1.96	22.1	0.87	10.2	0.40	15/16	1-1/16	1/2	7/8 - 14	7/8 - 14

MCF FEMALE TO MALE NPT CONNECTOR

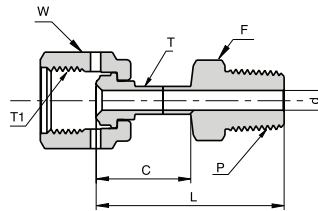

Ordering Information	Face Seal Size	L		C		d		F	W	T Tube O.D.	T1 Thread Size	P NPT-M
	inch	mm	inch	mm	inch	mm	inch	inch	inch	inch	inch	inch
P-MCF-1/4 X 1/4	1/4	45.5	1.79	23.4	0.92	4.60	0.18	9/16	3/4	1/4	9/16 - 18	1/4
P-MCF-1/2 X 1/2	1/2	53.1	2.09	25.6	1.01	10.2	0.40	7/8	1 1/16	1/2	7/8 - 14	1/2

UFF FEMALE TO FEMALE UNION

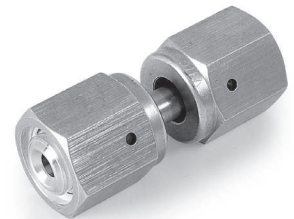
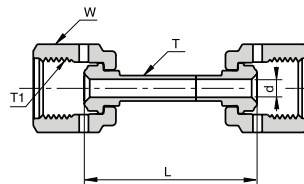

Ordering Information	Face Seal Size	L		d		W	T Tube O.D.	T1 Thread Size
	inch	mm	inch	mm	inch	inch	inch	inch
P-UFF-1/4 X 1/4	1/4	43.0	1.69	4.60	0.18	3/4	1/4	9/16 - 18
P-UFF-1/2 X 1/2	1/2	44.1	1.73	10.2	0.40	1 1/16	1/2	7/8 - 14

Dimensions are for reference only and are subject to change without notice.
When ordering, be sure to add the Surface-Finish Designator (either H or E) to the part number.

SWIVEL CONNECTORS

FCF FEMALE TO FEMALE NPT CONNECTOR

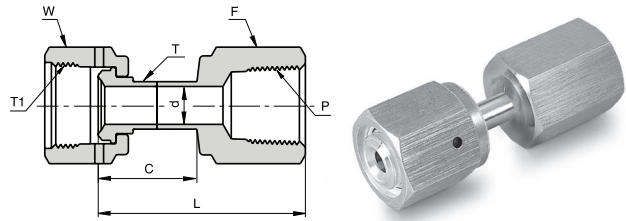

Ordering Information	Face Seal Size	L		C		d		F	W	T	T	P
	inch	mm	inch	mm	inch	mm	inch	inch	inch	inch	inch	inch
P-FCF-1/4 X 1/4	1/4	45.0	1.77	23.4	0.92	4.60	0.18	3/4	3/4	1/4	9/16 - 18	1/4
P-FCF-1/2 X 1/2	1/2	54.8	2.16	26.4	1.04	10.2	0.40	1 1/16	1 1/16	1/2	7/8 - 14	1/2

FHTL FEMALE TO LET-LOK CONNECTOR

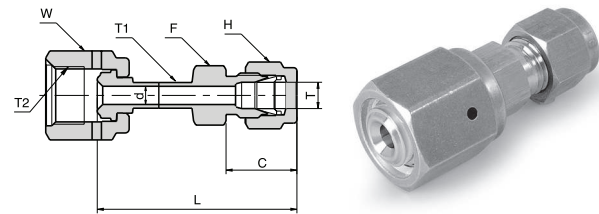

Ordering Information	Face Seal Size	L		C		d		F	W	H	T	T1	T2
	inch	mm	inch	mm	inch	mm	inch	inch	inch	inch	inch	inch	inch
P-FHTL-1/4 X 1/4	1/4	49.3	1.94	17.8	0.70	4.60	0.18	1/2	3/4	9/16	1/4	1/4	9/16 - 18
P-FHTL-1/2 X 1/2	1/2	56.6	2.23	21.8	0.86	10.2	0.40	13/16	1 1/16	7/8	1/2	1/2	7/8 - 14

CFFFF FEMALE CROSS UNION

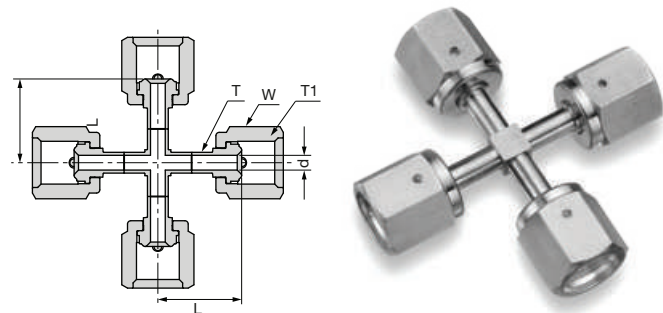

Ordering Information	Face Seal Size	L		d		W	T	T
	inch	mm	inch	mm	inch	inch	inch	inch
V-CFFFF 1/4	1/4	25.4	1	4.60	0.18	3/4	1/4	9/16-18

Dimensions are for reference only and are subject to change without notice.
When ordering, be sure to add the Surface-Finish Designator (either H or E) to the part number.

TFFF
FEMALE
TEE UNION

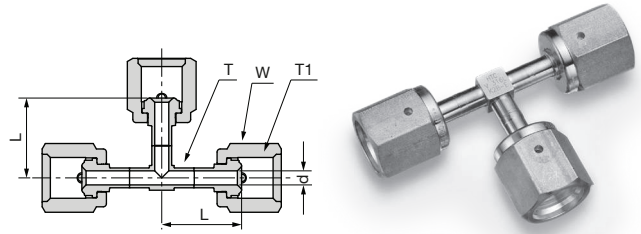

Ordering Information	Face Seal Size	L		d		W	T	T
	inch	mm	inch	mm	inch	inch	inch	inch
V-TFFF 1/4	1/4	25.4	1	4.60	0.18	3/4	1/4	9/16-18
V-TFFF 1/2	1/2	29.2	1.5	10.2	0.40	1-1/16	1/2	7/8-14

EFF
FEMALE
ELBOW UNION

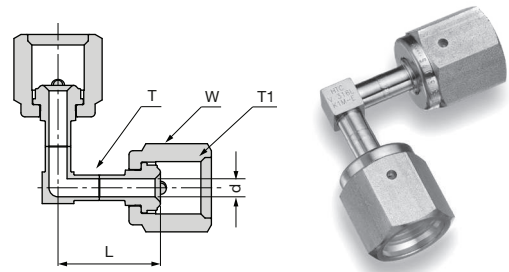

Ordering Information	Face Seal Size	L		d		W	T	T
	inch	mm	inch	mm	inch	inch	inch	inch
V-EFF 1/4	1/4	25.4	1	4.60	0.18	3/4	1/4	9/16-18
V-EFF 1/2	1/2	29.2	1.5	10.2	0.40	1-1/16	1/2	7/8-14

HGL LONG HIGH-FLOW GLAND

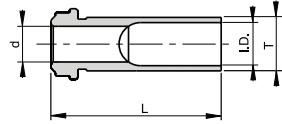

Ordering Information	Face Seal Size	L		d		T Tube O.D	I.D.	
		inch	mm	inch	mm		inch	mm
HGL-3/8 - 0.6	1/4	15.2	0.60	6.40	0.25	3/8	7.7	0.30
HGL-3/8 - 1.13	1/4	28.7	1.13	6.40	0.25	3/8	7.7	0.30
HGL-3/8 - 1.19	1/4	30.2	1.19	6.40	0.25	3/8	7.7	0.30
HGL-3/8 - 1.31	1/4	33.3	1.31	6.40	0.25	3/8	7.7	0.30

HMT HIGH-FLOW MALE TO TUBE

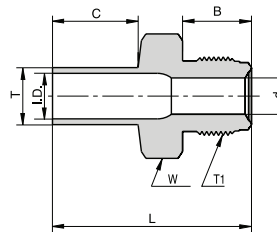

Ordering Information	Face Seal Size	L		B		C		d		W	T Tube O.D.	T1 Thread Size	I.D.	
		inch	mm	inch	mm	inch	mm	inch	mm				inch	
P - HMT 1/4	1/4	42.7	1.68	15.8	0.62	19.1	0.75	6.40	0.25	5/8	3/8	9/16 - 18	7.7	0.30

HNF HIGH-FLOW FEMALE NUT

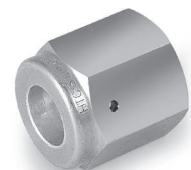
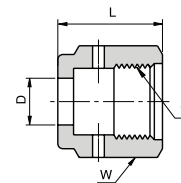

Ordering Information	Face Seal Size	L		D		W	T Thread Size
		inch	mm	inch	mm		
P - HNF 1/4	1/4	20.6	0.81	10.0	0.39	3/4	9/16 - 18

Dimensions are for reference only and are subject to change without notice.
When ordering, be sure to add the Surface-Finish Designator (either H or E) to the part number.

HIGH FLOW CONNECTORS

HNM HIGH-FLOW MALE NUT

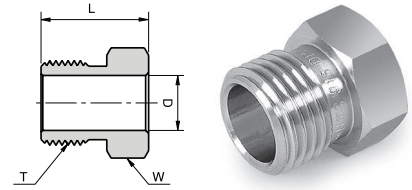

Ordering Information	Face Seal Size	L		D		T	W
	inch	mm	inch	mm	inch	inch	inch
P - HNM 1/4	1/4	18.0	0.71	10.0	0.39	9/16 - 18	5/8

HEU HIGH-FLOW ELBOW UNION

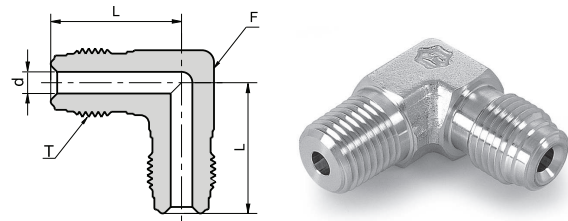

Ordering Information	Face Seal Size	L		d		F	T
	inch	mm	inch	mm	inch	inch	Thread Size
P-HEU-1/4	1/4	27.2	1.07	6.40	0.25	1/2	9/16-18

HTU HIGH-FLOW TEE UNION

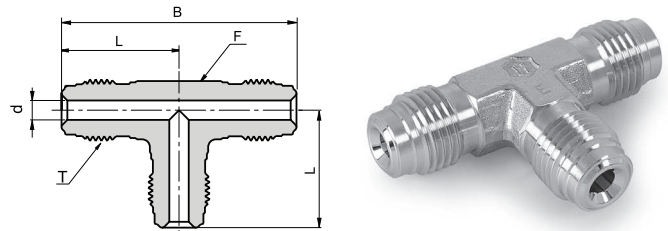

Ordering Information	Face Seal Size	L		B		d		F	T
	inch	mm	inch	mm	inch	mm	inch	inch	Thread Size
P-HTU-1/4	1/4	27.2	1.07	54.4	2.14	6.40	0.25	1/2	9/16-18

Dimensions are for reference only and are subject to change without notice.
When ordering, be sure to add the Surface-Finish Designator (either H or E) to the part number.

GASKETS

GA GASKET

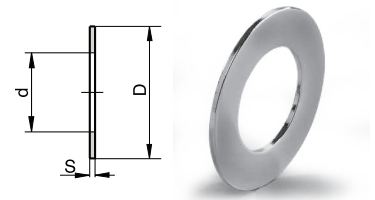

UNPLATED GASKETS

Ordering Information	Face Seal Size	D		d		S	
	inch	mm	inch	mm	inch	mm	inch
GA-1/4 - E	1/4	11.9	0.47	5.60	0.22	0.7	0.028
GA-1/2 - E	1/2	19.8	0.78	11.2	0.44	0.7	0.028
GA-3/4 - E	3/4	29.0	1.14	16.8	0.66	0.7	0.028
GA-1 - E	1	353.6	1.40	22.6	0.89	0.7	0.028

SILVER-PLATED GASKETS

Ordering Information	Face Seal Size	D		d		S	
	inch	mm	inch	mm	inch	mm	inch
GA-1/4 Silver Plated	1/4	11.9	0.47	5.60	0.22	0.7	0.028
GA-1/2 Silver Plated	1/2	19.8	0.78	11.2	0.44	0.7	0.028

GA-RT RETAINED GASKET

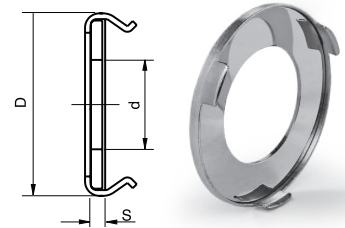

UNPLATED RETAINED GASKETS

Ordering Information	Face Seal Size	D		d		S	
	inch	mm	inch	mm	inch	mm	inch
GA-1/4 -RT - E	1/4	12.7	0.50	6.10	0.24	0.7	0.028
GA-1/2 -RT - E	1/2	20.1	0.79	11.1	0.44	0.7	0.028
GA-3/4-RT - E	3/4	29.0	1.14	16.8	0.66	0.7	0.028
GA-1 -RT - E	1	35.6	1.40	22.6	0.89	0.7	0.028

SILVER-PLATED RETAINED GASKETS

Ordering Information	Face Seal Size	D		d		S	
	inch	mm	inch	mm	inch	mm	inch
GA-1/4-RT Silver Plated	1/4	12.7	0.50	6.10	0.24	0.7	0.028
GA-1/2-RT Silver Plated	1/2	20.1	0.79	11.1	0.44	0.7	0.028

SS - GA-1/4

HOW TO ORDER:
Example:

Material Description	
SS -	Stainless Steel
NI -	Nickel

Dimensions are for reference only, and are subject to change without notice.

When ordering, be sure to add the Surface-Finish Designator (either H or E) to the part number. (See Material Table, page 157). All orders should include the material description and ordering information (see product table).

GA-VL
VERTICAL LOAD GASKET

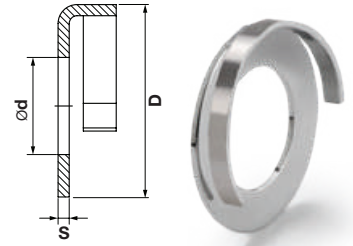

UNPLATED GASKETS

Ordering Information	Face Seal Size	D		d		S	
	inch	mm	inch	mm	inch	mm	inch
SS-GA-1/4-VL-E	1/4	12.3	0.48	6.20	0.24	0.7	0.028
SS-GA-1/2-VL-E	1/2	19.7	0.78	11.0	0.43	0.7	0.028
NI-GA-1/4-VL-E	1/4	12.3	0.48	6.20	0.24	0.7	0.028
NI-GA-1/2-VL-E	1/2	19.7	0.78	11.0	0.43	0.7	0.028

**ME-W
MINI ELBOW**

Without shoulder

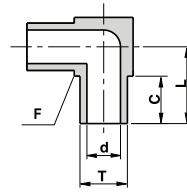

Ordering Information	L		C		d		F	T Tube O.D	W.T.	
	mm	inch	mm	inch	mm	inch	inch	inch / mm	mm	inch
V-ME-1/8-W	10.3	0.41	6.4	0.25	1.90	0.07	5/16	1/8"	-	0.028
V-ME-1/4-W	10.3	0.41	6.4	0.25	4.60	0.18	5/16	1/4"	-	0.035
V-ME-3/8-W	11.9	0.47	6.4	0.25	7.70	0.30	7/16	3/8"	-	0.035
V-ME-1/2-W	13.5	0.53	6.4	0.25	10.2	0.40	9/16	1/2"	-	0.049
V-ME-1/2-W W.T.=0.065	13.5	0.53	6.4	0.25	9.50	0.37	9/16	1/2"	-	0.065
V-ME-6MM-W	10.3	0.41	6.4	0.25	4.00	0.16	5/16	6mm	1.00	-
V-ME-8MM-W	11.9	0.47	6.4	0.25	6.00	0.24	7/16	8mm	1.00	-
V-ME-10MM-W	11.9	0.47	6.4	0.25	8.00	0.31	7/16	10mm	1.00	-
V-ME-12MM-W	13.5	0.53	6.4	0.25	10.0	0.39	9/16	12mm	1.00	-

**MER-W
MINI ELBOW REDUCER**

Without shoulder

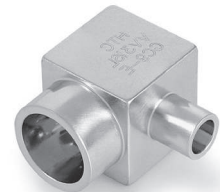
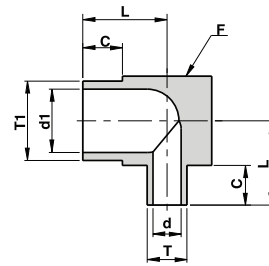

Ordering Information	L		C		d1		d		F	T1 Tube O.D	W.T. (T1)		T Tube O.D	W.T. (T)	
	mm	inch	mm	inch	mm	inch	mm	inch	inch	inch/mm	mm	inch	inch/mm	mm	inch
V-MER-1/4 X 1/8-W	10.3	0.41	6.4	0.25	4.60	0.18	1.90	0.07	5/16	1/4"	-	0.035	1/8"	-	0.028
V-MER-3/8 X 1/4-W	11.9	0.47	6.4	0.25	7.70	0.30	4.60	0.18	7/16	3/8"	-	0.035	1/4"	-	0.035
V-MER-1/2 X 1/4-W	13.5	0.53	6.4	0.25	10.2	0.40	4.60	0.18	9/16	1/2"	-	0.049	1/4"	-	0.035
V-MER-1/2 X 3/8-W	13.5	0.53	6.4	0.25	10.2	0.40	7.70	0.30	9/16	1/2"	-	0.049	3/8"	-	0.035
V-MER-8MM X 6MM-W	11.9	0.47	6.4	0.25	6.00	0.24	4.00	0.16	7/16	8mm	1.00	-	6mm	1.00	-
V-MER-12MM X 6MM-W	13.5	0.53	6.4	0.25	10.0	0.39	4.00	0.16	9/16	12mm	1.00	-	6mm	1.00	-
V-MER-12MM X 8MM-W	13.5	0.53	6.4	0.25	10.0	0.39	6.00	0.24	9/16	12mm	1.00	-	8mm	1.00	-

MINI BUTTWELD

ME-45°-W

MINI ELBOW 45°

Without shoulder

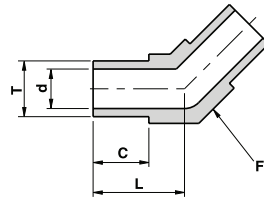

Ordering Information	L		C		d		F	T	W.T.	
	mm	inch	mm	inch	mm	inch	inch	inch / mm	mm	inch
V-ME-1/4-W-45DEG	10.3	0.41	6.4	0.25	4.60	0.18	5/16	1/4"	-	0.035
V-ME-3/8-W-45DEG	11.9	0.47	6.4	0.25	7.70	0.30	7/16	3/8"	-	0.035
V-ME-1/2-W-45DEG	13.5	0.53	6.4	0.25	10.2	0.40	9/16	1/2"	-	0.049
V-ME-1/2-W-45DEG W.T.=0.065	13.5	0.53	6.4	0.25	9.50	0.37	9/16	1/2"	-	0.065
V-ME-6MM-W-45DEG	10.3	0.41	6.4	0.25	4.00	0.16	5/16	6mm	1.00	-
V-ME-8MM-W-45DEG	11.9	0.47	6.4	0.25	6.00	0.24	7/16	8mm	1.00	-
V-ME-10MM-W-45DEG	11.9	0.47	6.4	0.25	8.00	0.31	7/16	10mm	1.00	-
V-ME-12MM-W-45DEG	13.5	0.53	6.4	0.25	10.0	0.39	9/16	12mm	1.00	-

MEX-W

MINI ELBOW

With extended leg

Without shoulder

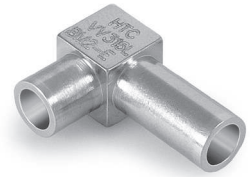
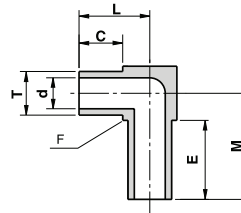

Ordering Information	L		C		M		E		d		F	T	W.T.
	mm	inch	mm	inch	mm	inch	mm	inch	mm	inch	inch	inch	inch
V-MEX-1/4-W 0.41X0.66	10.3	0.41	6.4	0.25	16.8	0.66	12.7	0.50	4.6	0.18	5/16	1/4"	0.035
V-MEX-1/4-W 0.41X0.61	10.3	0.41	6.4	0.25	15.4	0.61	11.4	0.45	4.6	0.18	5/16	1/4"	0.035
V-MEX-1/4-W 0.66X0.66"	16.8	0.66	12.7	0.50	16.8	0.66	12.7	0.50	4.6	0.18	5/16	1/4"	0.035

MT-W

MINI TEE

Without shoulder

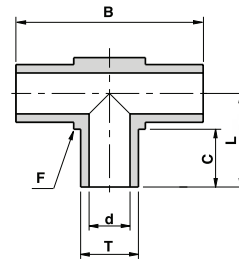

Ordering Information	L		B		C		d		F	T	W.T.	
	mm	inch	mm	inch	mm	inch	mm	inch	inch	inch / mm	mm	inch
V-MT-1/8-W	10.3	0.41	20.7	0.81	6.4	0.25	1.90	0.07	5/16	1/8"	-	0.028
V-MT-1/4-W	10.3	0.41	20.7	0.81	6.4	0.25	4.60	0.18	5/16	1/4"	-	0.035
V-MT-3/8-W	11.9	0.47	23.9	0.94	6.4	0.25	7.70	0.30	7/16	3/8"	-	0.035
V-MT-1/2-W	13.5	0.53	27.1	1.07	6.4	0.25	10.2	0.40	9/16	1/2"	-	0.049
V-MT-1/2-W W.T.=0.065	13.5	0.53	27.1	1.07	6.4	0.25	9.50	0.37	9/16	1/2"	-	0.065
V-MT-6MM-W	10.3	0.41	20.7	0.81	6.4	0.25	4.00	0.16	5/16	6mm	1.00	-
V-MT-8MM-W	11.9	0.47	23.9	0.94	6.4	0.25	6.00	0.24	7/16	8mm	1.00	-
V-MT-10MM-W	11.9	0.47	23.9	0.94	6.4	0.25	8.00	0.31	7/16	10mm	1.00	-
V-MT-12MM-W	13.5	0.53	27.1	1.07	6.4	0.25	10.0	0.39	9/16	12mm	1.00	-

MTR-W
MINI TEE REDUCER

Without shoulder

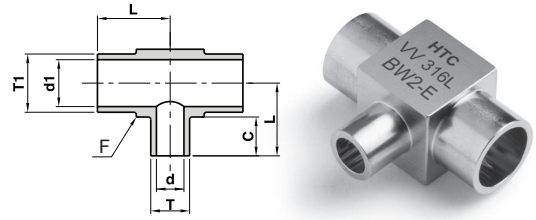

Ordering Information	L		B		C		d1		d		F	T1 Tube O.D	W.T. (T1)		T Tube O.D		W.T. (T)	
	mm	inch	mm	inch	mm	inch	mm	inch	mm	inch	inch	inch/mm	mm	inch	inch/mm	mm	inch	
V-MTR-1/2 X 1/4-W	13.5	0.53	27.1	1.07	6.4	0.25	10.2	0.40	4.6	0.18	9/16	1/2"	-	0.049	1/4"	-	0.035	
V-MTR-1/2 X 3/8-W	13.5	0.53	27.1	1.07	6.4	0.25	10.2	0.40	7.7	0.30	9/16	1/2"	-	0.049	3/8"	-	0.035	
V-MTR-3/8 X 1/4-W	11.9	0.47	23.9	0.94	6.4	0.25	7.70	0.30	4.6	0.18	7/16	3/8"	-	0.035	1/4"	-	0.035	
V-MTR-8MMX6MM-W	11.9	0.47	23.9	0.94	6.4	0.25	6.00	0.24	4.0	0.16	7/16	8mm	1.00	-	6mm	1.00	-	
V-MTR-12MMX6MM-W	13.5	0.53	27.1	1.07	6.4	0.25	10.0	0.39	4.0	0.16	9/16	12mm	1.00	-	6mm	1.00	-	
V-MTR-12MMX8MM -W	13.5	0.53	27.1	1.07	6.4	0.25	10.0	0.39	6.0	0.24	9/16	12mm	1.00	-	8mm	1.00	-	

MC-W
MINI CROSS

Without shoulder

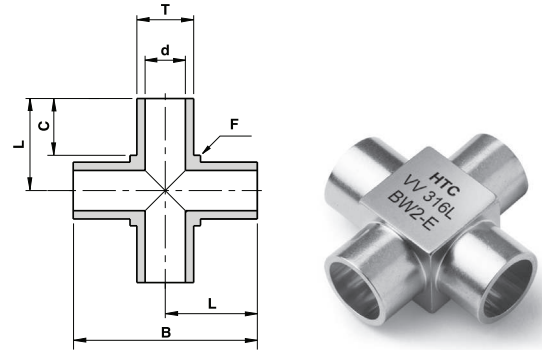

Ordering Information	L		B		C		d		F	T Tube O.D	W.T.	
	mm	inch	mm	inch	mm	inch	mm	inch	inch	inch/mm	mm	inch
V-MC-1/8-W	10.3	0.41	20.7	0.81	6.4	0.25	1.90	0.07	5/16	1/8"	-	0.028
V-MC-1/4-W	10.3	0.41	20.7	0.81	6.4	0.25	4.60	0.18	5/16	1/4"	-	0.035
V-MC-3/8-W	11.9	0.47	23.9	0.94	6.4	0.25	7.70	0.30	7/16	3/8"	-	0.035
V-MC-1/2-W	13.5	0.53	27.1	1.07	6.4	0.25	10.2	0.40	9/16	1/2"	-	0.049
V-MC-1/2-W W.T.=0.065	13.5	0.53	27.1	1.07	6.4	0.25	9.50	0.37	9/16	1/2"	-	0.065
V-MC-6MM-W	10.3	0.41	20.7	0.81	6.4	0.25	4.00	0.16	5/16	6mm	1.00	-
V-MC-8MM-W	11.9	0.47	23.9	0.94	6.4	0.25	6.00	0.24	7/16	8mm	1.00	-
V-MC-10MM-W	11.9	0.47	23.9	0.94	6.4	0.25	8.00	0.31	7/16	10mm	1.00	-
V-MC-12MM-W	13.5	0.53	27.1	1.07	6.4	0.25	10.0	0.39	9/16	12mm	1.00	-

Dimensions are for reference only and are subject to change without notice.
When ordering, be sure to add the Surface-Finish Designator (either H or E) to the part number.

MINI BUTTWELD

MTB-W MINI TRI-EL

Without shoulder

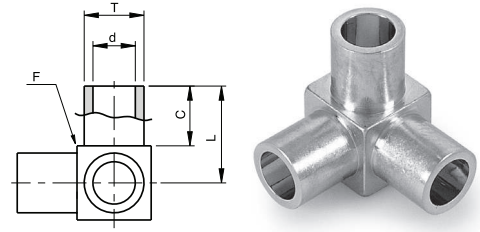

Ordering Information	L		C		d		F	T Tube O.D	W.T.	
	mm	inch	mm	inch	mm	inch	inch	inch / mm	mm	inch
V-MTB-1/8-W	10.3	0.41	6.4	0.25	1.90	0.07	5/16	1/8"	-	0.028
V-MTB-1/4-W	10.3	0.41	6.4	0.25	4.60	0.18	5/16	1/4"	-	0.035
V-MTB-3/8-W	11.9	0.47	6.4	0.25	7.70	0.30	7/16	3/8"	-	0.035
V-MTB-1/2-W	13.5	0.53	6.4	0.25	10.2	0.40	9/16	1/2"	-	0.049
V-MTB-6MM-W	10.3	0.41	6.4	0.25	4.00	0.16	5/16	6mm	1.00	-
V-MTB-8MM-W	11.9	0.47	6.4	0.25	6.00	0.24	7/16	8mm	1.00	-
V-MTB-10MM-W	11.9	0.47	6.4	0.25	8.00	0.31	7/16	10mm	1.00	-
V-MTB-12MM-W	13.5	0.53	6.4	0.25	10.0	0.39	9/16	12mm	1.00	-

RU-W REDUCING UNION

Without shoulder

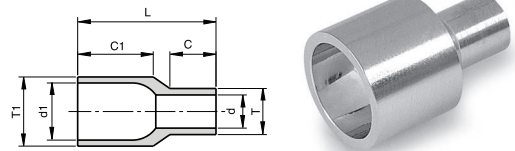

Ordering Information	L		C1		C		d1		d		T1 Tube O.D	W.T. (T1)		T Tube O.D	W.T. (T)	
	mm	inch	mm	inch	mm	inch	mm	inch	mm	inch	inch/ mm	mm	inch	inch/ mm	mm	inch
RU-1/4 X 1/8-W	19.1	0.75	10.4	0.41	6.4	0.25	4.60	0.18	1.9	0.07	1/4"	-	0.035	1/8"	-	0.028
RU-3/8 X 1/4-W	19.1	0.75	10.4	0.41	6.4	0.25	7.70	0.30	4.6	0.18	3/8"	-	0.035	1/4"	-	0.035
RU-1/2 X 1/4-W	19.1	0.75	10.4	0.41	6.4	0.25	10.2	0.40	4.6	0.18	1/2"	-	0.049	1/4"	-	0.035
RU-1/2 X 3/8-W	19.1	0.75	10.4	0.41	6.4	0.25	10.2	0.40	7.7	0.30	1/2"	-	0.049	3/8"	-	0.035
RU- 1 X 1/2-W	19.1	0.75	10.4	0.41	6.4	0.25	22.1	0.87	10.2	0.40	1"	-	0.065	1/2"	-	0.049
RU- 8MM X 6MM-W	19.1	0.75	10.4	0.41	6.4	0.25	6.00	0.24	4.0	0.16	8mm	1.00	-	6mm	1.00	-
RU- 10MM X 6MM-W	19.1	0.75	10.4	0.41	6.4	0.25	8.00	0.31	4.0	0.16	10mm	1.00	-	6mm	1.00	-
RU- 10MM X 8MM-W	19.1	0.75	10.4	0.41	6.4	0.25	8.00	0.31	6.0	0.24	10mm	1.00	-	8mm	1.00	-
RU- 12MM X 6MM-W	19.1	0.75	10.4	0.41	6.4	0.25	10.0	0.39	4.0	0.16	12mm	1.00	-	6mm	1.00	-
RU- 12MM X 8MM-W	19.1	0.75	10.4	0.41	6.4	0.25	10.0	0.39	6.0	0.24	12mm	1.00	-	8mm	1.00	-
RU- 12MM X 10MM-W	19.1	0.75	10.4	0.41	6.4	0.25	10.0	0.39	8.0	0.31	12mm	1.00	-	10mm	1.00	-

Dimensions are for reference only and are subject to change without notice.
When ordering, be sure to add the Surface-Finish Designator (either H or E) to the part number.

LONG WELD CONNECTORS

EW-W ELBOW

Without shoulder

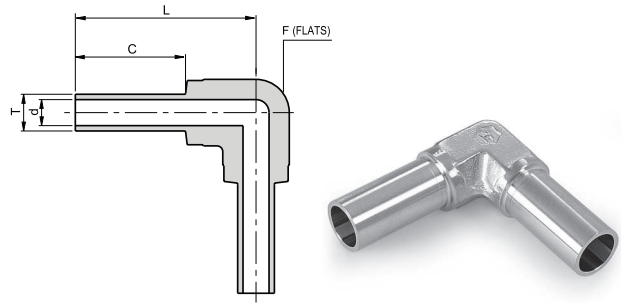

Ordering Information	L		C		d		F	T	W.T.	
	mm	inch	mm	inch	mm	inch	inch	inch/mm	mm	inch
P-EW-1/4-W	31.2	1.23	19.1	0.75	4.60	0.18	7/16	1/4"	-	0.035
P-EW-3/8-W	30.5	1.20	19.1	0.75	7.07	0.30	7/16	3/8"	-	0.035
P-EW-1/2-W	34.0	1.34	19.1	0.75	10.2	0.40	11/16	1/2"	-	0.049
P-EW-1/2-W W.T.=0.065	34.0	1.34	19.1	0.75	9.50	0.37	11/16	1/2"	-	0.065
P-EW-3/4-W W.T.=0.049	37.1	1.46	19.1	0.75	16.6	0.65	15/16	3/4"	-	0.049
P-EW-3/4-W W.T.=0.065	37.1	1.46	19.1	0.75	15.8	0.62	15/16	3/4"	-	0.065
P-EW-1-W W.T.=0.065	47.0	1.85	24.4	0.96	22.1	0.87	1 3/8	1"	-	0.065
P-EW-1-W W.T.=0.120	47.0	1.85	24.4	0.96	19.4	0.76	1 3/8	1"	-	0.120
P-EW-6M-W	31.2	1.23	19.1	0.75	4.00	0.16	7/16	6mm	1.00	-
P-EW-8MM-W	31.2	1.23	19.1	0.75	6.00	0.24	7/16	8mm	1.00	-
P-EW-10MM-W	34.0	1.34	19.1	0.75	8.00	0.31	11/16	10mm	1.00	-
P-EW-12MM-W	34.0	1.34	19.1	0.75	10.0	0.39	11/16	12mm	1.00	-

TW-W TEE

Without shoulder

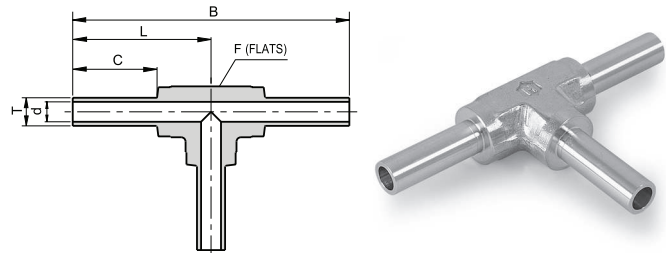

Ordering Information	L		B		C		d		F	T	W.T.	
	mm	inch	mm	inch	mm	inch	mm	inch	inch	inch/mm	mm	inch
P-TW-1/4-W	31.2	1.23	62.5	2.46	19.1	0.75	4.60	0.18	7/16	1/4"	-	0.035
P-TW-3/8-W	30.5	1.20	61.0	2.40	19.1	0.75	7.70	0.30	7/16	3/8"	-	0.035
P-TW-1/2-W	34.0	1.34	68.1	2.68	19.1	0.75	10.2	0.40	11/16	1/2"	-	0.049
P-TW-1/2-W W.T.=0.065	34.0	1.34	68.1	2.68	19.1	0.75	9.50	0.37	11/16	1/2"	-	0.065
P-TW-3/4-W W.T.=0.065	37.1	1.46	74.2	2.92	19.1	0.75	15.8	0.62	15/16	3/4"	-	0.065
P-TW-3/4-W W.T.=0.049	37.1	1.46	74.2	2.92	19.1	0.75	16.6	0.65	15/16	3/4"	-	0.049
P-TW-1-W W.T.=0.065	47.0	1.85	94.0	3.70	24.4	0.96	22.1	0.87	1 3/8	1"	-	0.065
P-TW-1-W W.T.=0.120	47.0	1.85	94.0	3.70	24.4	0.96	19.4	0.76	1 3/8	1"	-	0.120
P-TW-6MM-W	31.2	1.23	62.5	2.46	19.1	0.75	4.00	0.16	7/16	6mm	1.00	-
P-TW-8MM-W	31.2	1.23	62.5	2.46	19.1	0.75	6.00	0.24	7/16	8mm	1.00	-
P-TW-10MM-W	34.0	1.34	68.1	2.68	19.1	0.75	8.00	0.31	11/16	10mm	1.00	-
P-TW-12MM-W	34.0	1.34	68.1	2.68	19.1	0.75	10.0	0.39	11/16	12mm	1.00	-

Dimensions are for reference only and are subject to change without notice.
When ordering, be sure to add the Surface-Finish Designator (either H or E) to the part number.

LONG WELD CONNECTORS

TWR-W TEE REDUCER

Without shoulder

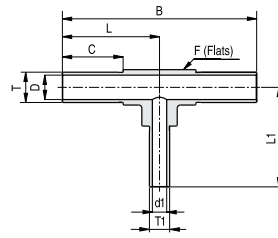

Ordering Information	L		L1		B		C		d		d1		F	T	W.T.	T1	W.T.
	mm	inch	mm	inch	mm	inch	mm	inch	mm	inch	mm	inch	inch	Tube O.D.	inch/mm	inch/mm	Tube O.D.
P-TWR-3/8X1/4 W	30.5	1.20	31.2	1.23	61.0	2.40	19.1	0.75	7.7	0.30	4.60	0.18	7/16	3/8"	0.035"	1/4"	0.035"
P-TWR-1/2X1/4 W	34.0	1.34	34.0	1.34	68.0	2.68	19.1	0.75	10.2	0.40	4.60	0.18	11/16	1/2"	0.049"	1/4"	0.035"
P-TWR-1/2X3/8 W	34.0	1.34	34.0	1.34	68.0	2.68	19.1	0.75	10.2	0.40	7.70	0.30	11/16	1/2"	0.049"	3/8"	0.035"
P-TWR-3/4X1/4 W W.T.= 0.049 X 0.035	37.1	1.46	37.1	1.46	74.2	2.92	19.1	0.75	16.6	0.65	4.60	0.18	15/16	3/4"	0.049"	1/4"	0.035"
P-TWR-3/4X1/4 W W.T.=0.065 X 0.035	37.1	1.46	37.1	1.46	74.2	2.92	19.1	0.75	15.8	0.62	4.60	0.18	15/16	3/4"	0.065"	1/4"	0.035"
P-TWR-3/4X1/2 W W.T.=0.049	37.1	1.46	37.1	1.46	74.2	2.92	19.1	0.75	16.6	0.65	10.2	0.40	15/16	3/4"	0.049"	1/2"	0.049"
P-TWR-12MMX6MM W	34.0	1.34	34.0	1.34	68.0	2.68	19.1	0.75	10.0	0.39	4.00	0.16	11/16	12mm	1.00mm	6mm	1.00mm

CW-W CROSS

Without shoulder

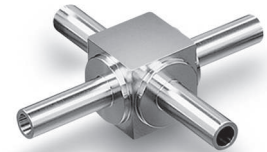
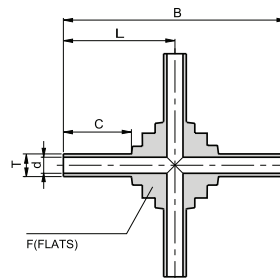

Ordering Information	L		B		C		d		F	T	W.T.	
	mm	inch	mm	inch	mm	inch	mm	inch	inch/mm	Tube O.D.	mm	inch
P-CW-1/4-W	31.2	1.23	62.5	2.46	19.1	0.75	4.60	0.18	17mm	1/4"	-	0.035
P-CW-3/8-W	30.5	1.20	61.0	2.40	19.1	0.75	7.70	0.30	17mm	3/8"	-	0.035
P-CW-1/2-W	31.0	1.22	62.0	2.44	19.1	0.75	10.2	0.40	17mm	1/2"	-	0.049
P-CW-1/2-W W.T.=0.065	31.0	1.22	62.0	2.44	19.1	0.75	9.50	0.37	17mm	1/2"	-	0.065
P-CW-6MM-W	31.2	1.23	62.5	2.46	19.1	0.75	4.00	0.16	17mm	6mm	1.00	-
P-CW-8MM-W	30.5	1.20	61.0	2.40	19.1	0.75	6.00	0.24	17mm	8mm	1.00	-
P-CW-10MM-W	31.0	1.22	62.0	2.44	19.1	0.75	8.00	0.31	17mm	10mm	1.00	-
P-CW-12MM-W	31.0	1.22	62.0	2.44	19.1	0.75	10.0	0.39	17mm	12mm	1.00	-

Dimensions are for reference only and are subject to change without notice.
When ordering, be sure to add the Surface-Finish Designator (either H or E) to the part number.

LONG WELD CONNECTORS

RW-W REDUCER

Without shoulder

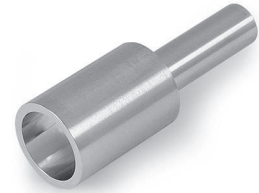
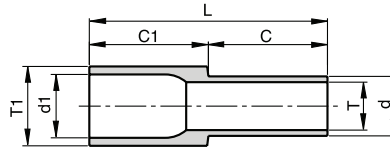

Ordering Information	L		C		d1		d		T1 Tube O.D.	W.T. (T1)		T Tube O.D.	W.T. (T)	
	mm	inch	mm	inch	mm	inch	mm	inch	inch/mm	mm	inch	inch/mm	mm	inch
RW-1/4X1/8-W	38.1	1.50	19.1	0.75	4.60	0.18	1.9	0.07	1/4"	-	0.035	1/8"	-	0.028
RW-3/8X1/4-W	38.1	1.50	19.1	0.75	7.70	0.30	4.6	0.18	3/8"	-	0.035	1/4"	-	0.035
RW-1/2X1/4-W	38.1	1.50	19.1	0.75	10.2	0.40	4.6	0.18	1/2"	-	0.049	1/4"	-	0.035
RW-1/2X3/8-W	38.1	1.50	19.1	0.75	10.2	0.40	7.7	0.30	1/2"	-	0.049	3/8"	-	0.035
RW-8MM X 6MM-W	38.1	1.50	19.1	0.75	6.00	0.24	4.0	0.16	8mm	1.00	-	6mm	1.00	-
RW-10MM X 6MM-W	38.1	1.50	19.1	0.75	8.00	0.31	4.0	0.16	10mm	1.00	-	6mm	1.00	-
RW-10MM X 8MM-W	38.1	1.50	19.1	0.75	8.00	0.31	6.0	0.24	10mm	1.00	-	8mm	1.00	-
RW-12MM X 6MM-W	38.1	1.50	19.1	0.75	10.0	0.39	4.0	0.16	12mm	1.00	-	6mm	1.00	-
RW-12MM X 8MM-W	38.1	1.50	19.1	0.75	10.0	0.39	6.0	0.24	12mm	1.00	-	8mm	1.00	-
RW-12MM X 10MM-W	38.1	1.50	19.1	0.75	10.0	0.39	8.0	0.31	12mm	1.00	-	10mm	1.00	-

RW-W REDUCER BIG SIZE

Without shoulder

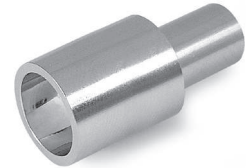
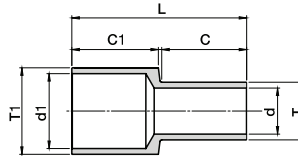

Ordering Information	L		C1		C		d1		d		T1 Tube O.D.	W.T. (T1)		T Tube O.D.	W.T. (T)	
	mm	inch	mm	inch	mm	inch	mm	inch	mm	inch	inch/mm	mm	inch	inch/mm	mm	inch
RW-3/4X1/2 W W.T.=0.049	38.5	1.51	19.1	0.75	19.1	0.75	16.6	0.65	10.2	0.40	3/4"	-	0.049	1/2"	-	0.049
RW-3/4X1/2 W W.T.=0.065X0.049	38.5	1.51	19.1	0.75	19.1	0.75	15.8	0.62	10.2	0.40	3/4"	-	0.065	1/2"	-	0.065
RW-3/4X1/4 W W.T.=0.049X0.035	38.5	1.51	19.1	0.75	19.1	0.75	16.6	0.65	4.6	0.18	3/4"	-	0.049	1/4"	-	0.049
RW-1X1/2 W W.T.= 0.065X0.049	40.5	1.59	19.1	0.75	19.1	0.75	22.1	0.87	10.2	0.40	1"	-	0.065	1/2"	-	0.049

UB-W BUTTWELD UNION

Without shoulder



Ordering Information	L		d		T Tube O.D	W.T.
	mm	inch	mm	inch	inch	inch
UB-1/4-W	24.3	0.96	4.60	0.18	1/4	0.035
UB-3/8-W	23.9	0.94	7.70	0.30	3/8	0.035
UB-1/2-W	23.4	0.92	10.2	0.40	1/2	0.049
UB-3/4-W W.T.=0.049	23.4	0.92	16.6	0.65	3/4	0.049
UB-3/4-W W.T.=0.065	23.4	0.92	15.8	0.62	3/4	0.065
UB-1-W W.T.=0.065	29.7	1.17	22.1	0.87	1	0.065

LONG SHAPED CONNECTORS

UB-S BUTTWELD UNION

With shoulder

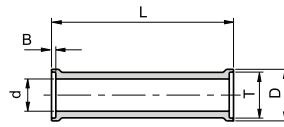

Ordering Information	L		d		B		D		T	W.T.
	mm	inch	mm	inch	mm	inch	mm	inch	Tube O.D.	
UB-1/4-S	25.4	1.00	4.60	0.18	0.55	0.02	7.4	0.29	1/4	0.035
UB-3/8-S	25.4	1.00	7.70	0.30	0.76	0.03	10.4	0.41	3/8	0.035
UB-1/2-S	25.4	1.00	10.2	0.40	1.00	0.04	14.0	0.55	1/2	0.049
UB-3/4-S W.T.=0 .049	25.4	1.00	16.5	0.65	1.00	0.04	20.3	0.80	3/4	0.049
UB-3/4-S W.T.=0 .065	25.4	1.00	15.8	0.62	1.00	0.04	20.3	0.80	3/4	0.065
UB-1-S W.T.=0 .065	31.8	1.25	22.1	0.87	1.00	0.04	26.9	1.06	1	0.065

UBL-S BUTTWELD UNION

With locator and shoulder

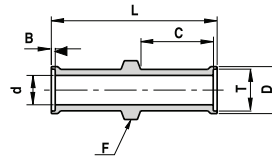

Ordering Information	L		C		d		B		D		F		T	W.T.
	mm	inch	mm	inch	mm	inch	mm	inch	mm	inch	mm	inch	Tube O.D.	
UBL-1/4-S	42.9	1.69	19.1	0.75	4.60	0.18	0.6	0.02	7.4	0.29	9.1	0.36	1/4	0.035
UBL-3/8-S	43.4	1.71	19.1	0.75	7.70	0.30	0.8	0.03	10.4	0.41	10.7	0.42	3/8	0.035
UBL-1/2-S	43.9	1.73	19.1	0.75	10.2	0.40	1.0	0.04	14.0	0.55	15.2	0.60	1/2	0.049

Dimensions are for reference only and are subject to change without notice.
When ordering, be sure to add the Surface-Finish Designator (either H or E) to the part number.

GRIPKIT

Gripkit is a patented product designed to help preventing potential leaks in metal-gasket face seal fittings. The Gripkit is designed for use with critical, semiconductor-industry ultra-pure and high-purity gas applications, as well as vacuum delivery systems. The product is color coded for easy identification within the system and is engineered to be used with the fitting components of most major manufacturers.

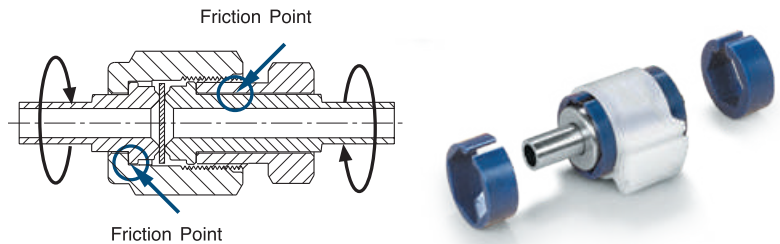

MATERIALS

GRIPKIT CONSISTS OF THREE COMPONENTS:

Part Number	Description	Material
GK-NY-M4	5/8" Hex male crescent adapter	Blue nylon
GK-NY-F4	3/4" Hex female crescent adapter	Blue nylon
GK-1-CL-WH	White color coded clamp	Acetyl
GK-1-CL-BL	Blue color coded clamp	Acetyl
GK-1-CL-YL	Yellow color coded clamp	Acetyl
GK-1-CL-RD	Red color coded clamp	Acetyl
GK-1-CL-GR	Green color coded clamp	Acetyl



HOW IT WORKS

The Gripkit fixes the position of the male nut relative to the female nut, and therefore, the distance between the two sealing glands. Consequently, when torque is applied to either side of the fitting connection, it does not cause the nuts to rotate in opposition and lose their compression on the gasket. In extreme cases, when very high torque is applied to the fitting joint, the glands may rotate within the fixed nuts, but the connector will remain intact. Gripkit will prevent the kind of catastrophic leak that results from the loss of gland compression on the gasket.

WHY USE GRIPKIT ?

When pipe fitters, maintenance technicians and operators work on gas distribution systems, they can accidentally "torque" the system, causing fittings down-line to come apart. Most veteran gas system engineers recognize this common phenomenon. Another widespread problem occurs when a fitting connection "shakes apart" because it is mounted on, or near, vibrating equipment. Sources of system vibration include pumps, motors, pneumatic actuators, as well as mobile equipment. Gripkit® offers a very inexpensive solution to these real and potentially

1" x 5/8" CRESCENT SECTION

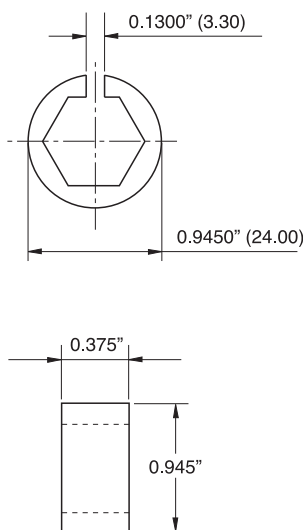

1" x 3/4" CRESCENT SECTION

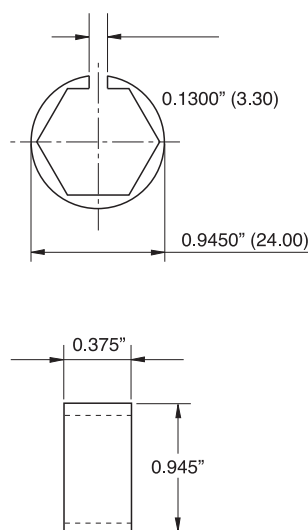

1" CLAMP SECTION

