



HAM-LET PRECISION INSTRUMENT PIPE FITTINGS

PIPELINE



GENERAL

Our pipeline connectors range is manufactured to fit typical applications in the chemical and petrochemical, oil, gas and power generation industries.

The exposed threads of the fittings are properly covered during packaging to prevent damage during delivery.

FEATURES

- Sizes range from 1/16" to 2"
- The exposed threads of the fittings are properly covered during packaging to prevent damage during delivery.
- All pipe threads meet the requirements of ASME/ANSI B1.20.1 (1983) for tapered pipe threads (NPT).
- Working pressures are calculated in accordance with Power Piping Code ANSI B 31.1, Refiner Piping Code ASME/ANSI B 31.3 and section VIII of ASME Boiler & Pressure Vessel Code.

PRESSURE RATINGS (PSI)

NPT or BSPT/ISO Size	STAINLESS STEEL 316		BRASS	
	Male	Female	Male	Female
1/16	11000	6700	5500	3300
1/8	10000	6500	5000	3200
1/4	8000	6600	4000	3300
3/8	7800	5300	3900	2600
1/2	7700	4900	3800	2400
3/4	7300	4600	3600	2300
1	5300	4400	2600	2200
1 1/4	6000	5000	3000	2500
1 1/2	5000	4600	2500	2300
2	3900	3900	1900	1900

MATERIALS

MATERIAL	Specifications	
	Barstock	Forgings
STAINLESS STEEL 316	ASTM A-276	ASTM A-182
	ASTM A-479	
BRASS	ASTM B-453	ASME B-283
	ASTM B-16	
	DIN 176.60	

INSTALLATION INSTRUCTIONS

To ensure a leak-tight seal, we recommend the use of a pipe thread sealant on all NPT threads. The most effective sealing method is PTFE tape. Tape should be used only on male tapered pipe threads.

Do not use tape on flared, coned or tube fitting ends!

Clean both male and female tapered threads and wrap tape in the direction of the male tapered thread spiral.

NOTE: Two wraps are suggested for stainless steel tapered pipe threads. Make sure tape does not overhang the first thread as the tape might shred and enter the fluid system.

Cut off excess tape. The connection is now ready for proper makeup.

PIPELINE INDEX

ELBOW
100 H



4

MALE ELBOW
100 HM



4

TEE
101H



4

MALE TEE
101HM



5

CROSS
102H



5

HEX COUPLING
103H



5

UNION BALL JOINT
104H



6

HOLLOW HEX PLUGS
107H



6

HOLLOW HEX PLUGS
SAE/MS STRAIGHT
THREAD BOSS
107HOB



6

PIPE CAP
108H



7

REDUCING BUSHING
110H



7

REDUCING BUSHING
SAE/MS STRAIGHT
THREAD BOSS
110HOB



8

HEX LONG NIPPLE
113H



8

STREET ELBOW
116H



9

HEX REDUCING COUPLING
119H



9

ADAPTER NPT
120H



10

ADAPTER
NPT FEMALE TO
MALE BSPT
120HNR



10

ADAPTER
FEMALE NPT TO MALE BSPP
120HNG



11

ADAPTER
NPT TO SAE/MS STRAIGHT
THREAD BOSS
120HNOB



11

ADAPTER
FEMALE BSPT TO
MALE NPT
120HRN



11

GAUGE ADAPTER
FEMALE BSPP TO
MALE NPT
120HGN



12

PIPE PLUG NPT
121H



12

HEX HEAD PLUG
SAE/MS STRAIGHT
THREAD BOSS
121HOB



12

HEX NIPPLE
122H



13

HEX NIPPLE
MALE NPT TO
MALE BSPT
122HNR



13

HEX NIPPLE
MALE NPT TO
MALE BSPP
122HNG



14

HEX NIPPLE
NPT TO SAE/MS
STRAIGHT BOSS
122HNOB



14

CLOSE NIPPLE
122HCN



14

REDUCING NIPPLE
123H



15

BRANCH TEE
3600H



15

STREET TEE
3750H



16

MALE HOSE CONNECTOR
130HM



16

FEMALE HOSE CONNECTOR
130HF



17

TUBE TO HOSE CONNECTOR
130LT



17

ORDERING INFORMATION

EXAMPLE:

120H

Material Description

SS -	Stainless Steel 316
B -	Brass

1/2

x

1/4

All orders should include ordering information and material description.

100 H ELBOW

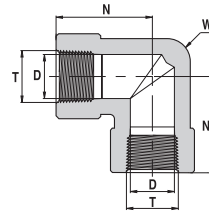

Ordering Information	T Female NPT Size	N		D Min. Opening		W Wrench Flat
	inch	inch	mm	inch	mm	inch
100H_ 1/8	1/8	1.04	26.4	0.31	7.8	5/8
100H_ 1/4	1/4	1.17	29.7	0.41	10.5	11/16
100H_ 3/8	3/8	1.42	36.1	0.56	14.2	15/16
100H_ 1/2	1/2	1.56	39.6	0.69	17.4	1 1/8
100H_ 3/4	3/4	1.92	48.8	0.90	22.9	1 3/8
100H_ 1	1	1.91	48.5	1.13	28.7	1 11/16

100 HM MALE ELBOW

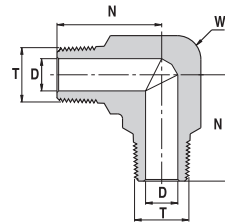

Ordering Information	T Female NPT Size	N		D Min. Opening		W Wrench Flat
	inch	inch	mm	inch	mm	inch
100HM_ 1/8	1/8	0.88	22.4	0.19	4.8	1/2
100HM_ 1/4	1/4	1.05	26.7	0.28	7.1	5/8
100HM_ 3/8	3/8	1.17	29.7	0.38	9.6	13/16
100HM_ 1/2	1/2	1.45	36.8	0.47	11.9	15/16

101 H TEE

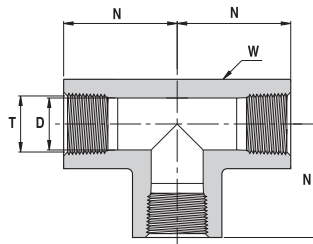

Ordering Information	A Female NPT Size	N		D Min. Opening		W Wrench Flat
	inch	inch	mm	inch	mm	inch
101H_ 1/8	1/8	1.04	26.4	0.31	7.8	5/8
101H_ 1/4	1/4	1.17	29.7	0.41	10.5	13/16
101H_ 3/8	3/8	1.42	36.1	0.56	14.2	15/16
101H_ 1/2	1/2	1.56	39.6	0.69	17.4	1 1/8
101H_ 3/4	3/4	1.92	48.8	0.90	22.9	1 3/8
101H_ 1	1	1.91	48.5	1.13	28.7	1 11/16

"D" Dimension is minimum opening. Dimensions are for reference only and subject to change without notice.

101 HM MALE TEE

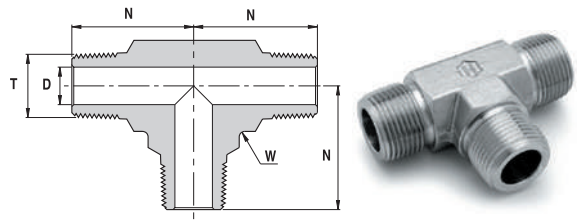

Ordering Information	T Female NPT Size	N		D Min. Opening		W Wrench Flat
	inch	inch	mm	inch	mm	inch
101HM _ 1/8	1/8	0.88	22.4	0.19	4.8	1/2
101HM _ 1/4	1/4	1.05	26.7	0.28	7.1	5/8
101HM _ 3/8	3/8	1.17	29.7	0.38	9.6	13/16
101HM _ 1/2	1/2	1.45	36.8	0.47	11.9	15/16

102 H CROSS

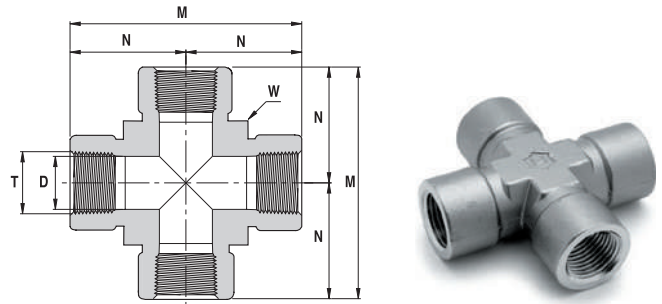

Ordering Information	T Female NPT Size	N		M		D Min. Opening		W Wrench Flat
	inch	inch	mm	inch	mm	inch	mm	inch
102H _ 1/8	1/8	1.04	26.4	2.08	52.8	0.31	7.8	5/8
102H _ 1/4	1/4	1.17	29.7	2.34	59.4	0.41	10.5	11/16
102H _ 3/8	3/8	1.42	36.1	2.84	72.2	0.56	14.2	13/16
102H _ 1/2	1/2	1.56	39.6	3.12	79.2	0.69	17.4	1
102H _ 3/4	3/4	1.92	48.8	3.84	97.6	0.90	22.9	1 1/4
102H _ 1	1	1.91	48.5	3.82	97.0	1.13	28.7	1 11/16

103 H HEX COUPLING

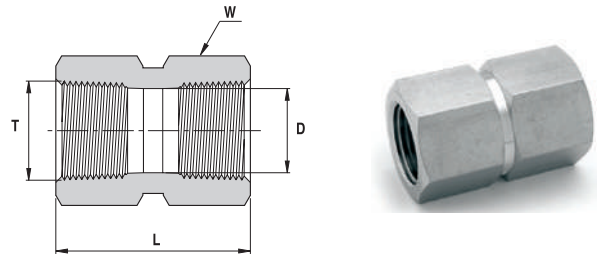

Ordering Information	T Female NPT Size	L		D Min. Opening		W Hex. Flat
	inch	inch	mm	inch	mm	inch
103H _ 1/8	1/8	0.81	20.6	0.31	7.8	9/16
103H _ 1/4	1/4	1.19	30.2	0.41	10.5	3/4
103H _ 3/8	3/8	1.31	33.3	0.56	14.2	7/8
103H _ 1/2	1/2	1.56	39.6	0.69	17.4	1 1/16
103H _ 3/4	3/4	1.62	41.1	0.90	22.9	1 5/16
103H _ 1	1	2.00	50.8	1.13	28.7	1 5/8

"D" Dimension is minimum opening. Dimensions are for reference only and subject to change without notice.

104 H UNION BALL JOINT

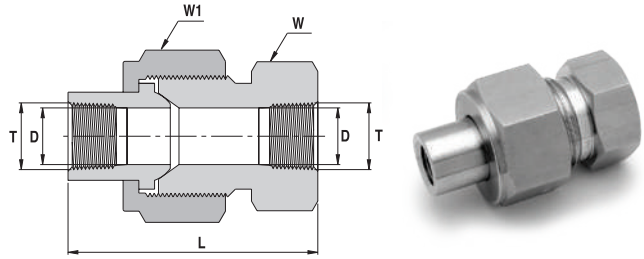

Ordering Information	T Female NPT Size	L		D Min. Opening		W Hex. Flat		W1 Hex. Flat
	inch	inch	mm	inch	mm	inch	mm	inch
104H_ 1/8	1/8	1.81	46.0	0.27	6.9	15/16	23.81	1 1/8
104H_ 1/4	1/4	2.34	59.4	0.36	9.1	1 3/16	30.16	1 3/8
104H_ 3/8	3/8	2.50	63.5	0.52	13.2	1 5/16	33.34	1 1/2
104H_ 1/2	1/2	2.69	68.3	0.62	15.7	1 5/8	41.28	1 3/4
104H_ 3/4	3/4	3.12	79.2	0.87	22.1	1 7/8	47.63	2
104H_ 1	1	3.56	90.4	1.03	26.2	2 3/8	60.33	2 1/2

107 H HOLLOW HEX PLUGS

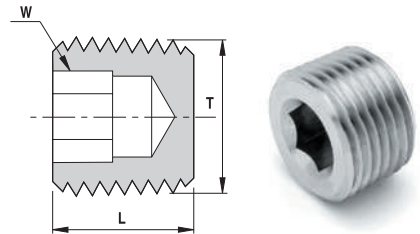

Ordering Information	T Female NPT Size	L		W Hex. Flat
	inch	inch	mm	inch
107H_ 1/8	1/8	0.29	7.4	3/16
107H_ 1/4	1/4	0.44	11.3	1/4
107H_ 3/8	3/8	0.44	11.3	5/16
107H_ 1/2	1/2	0.61	15.5	3/8

107HOB HOLLOW HEX PLUG SAE/MS STRAIGHT THREAD BOSS*

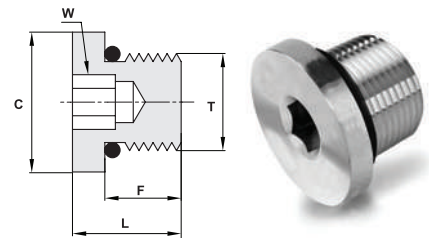

Ordering Information	T Straight Thread UN	L		F		C		W Hex. Flat	O-Ring**
	inch	inch	mm	inch	mm	inch	mm	inch	
107HOB_ 7/16-20	7/16-20	0.45	11.4	0.36	9.1	0.56	14.2	3/16	-904
107HOB_ 1/2-20	1/2-20	0.45	11.4	0.36	9.1	0.63	15.9	3/16	-905
107HOB_ 9/16-18	9/16-18	0.48	12.2	0.39	9.9	0.69	17.5	1/4	-906
107HOB_ 3/4-16	3/4-16	0.56	14.2	0.44	11.2	0.88	22.4	5/16	-908

*Per SAE J1926 and MS 16142.

**O-rings used are Fluorocarbon FKM 90 Durometer. Other O-ring materials available on request.

108 H PIPE CAP

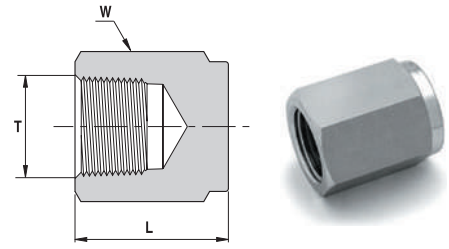

Ordering Information	T Female NPT Size	L		W Hex. Flat
	inch	inch	mm	inch
108H _ 1/8	1/8	0.75	19.1	9/16
108H _ 1/4	1/4	0.91	23.1	3/4
108H _ 3/8	3/8	1.03	26.2	7/8
108H _ 1/2	1/2	1.34	34.0	1 1/16
108H _ 3/4	3/4	1.44	36.6	1 5/16
108H _ 1	1	1.62	41.1	1 5/8

110 H REDUCING BUSHING

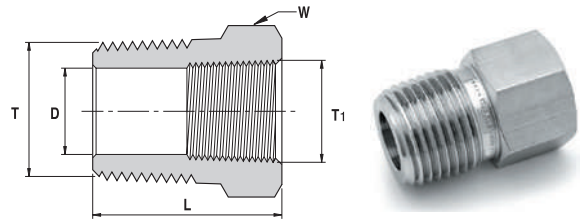

Ordering Information	T Female NPT Size	T1 Female NPT Size	L		D Min. Opening		W Hex. Flat
	inch		inch	mm	inch	mm	inch
110H _ 1/8 X 1/16	1/8	1/16	1.03	26.2	0.19	4.8	7/16
110H _ 1/4 X 1/8	1/4	1/8	1.06	26.9	0.28	7.1	9/16
110H _ 3/8 X 1/8	3/8	1/8	0.86	21.8	0.34	8.6	11/16
110H _ 3/8 X 1/4	3/8	1/4	1.19	30.2	0.38	9.6	3/4
110H _ 1/2 X 1/8	1/2	1/8	1.08	27.4	0.34	8.6	7/8
110H _ 1/2 X 1/4	1/2	1/4	1.08	27.4	0.41	10.5	7/8
110H _ 1/2 X 3/8	1/2	3/8	1.41	35.8	0.47	11.9	7/8
110H _ 3/4 X 1/4	3/4	1/4	1.08	27.4	0.45	11.4	1 1/16
110H _ 3/4 X 3/8	3/4	3/8	1.08	27.4	0.56	14.2	1 1/16
110H _ 3/4 X 1/2	3/4	1/2	1.63	41.4	0.62	15.7	1 1/16
110H _ 1 X 1/4	1	1/4	1.37	34.8	0.41	10.5	1 3/8
110H _ 1 X 3/8	1	3/8	1.37	34.8	0.56	14.2	1 3/8
110H _ 1 X 1/2	1	1/2	1.37	34.8	0.69	17.4	1 3/8
110H _ 1 X 3/4	1	3/4	1.85	47.0	0.87	22.1	1 3/8
110H _ 1 1/4 X 1/2	1 1/4	1/2	1.46	37.1	0.69	17.4	1 3/4
110H _ 1 1/4 X 3/4	1 1/4	3/4	1.47	37.3	0.90	22.9	1 3/4
110H _ 1 1/4 X 1	1 1/4	1	1.94	49.3	1.09	27.8	1 3/4
110H _ 1 1/2 X 1/2	1 1/2	1/2	1.61	40.9	0.72	18.3	2 1/8
110H _ 1 1/2 X 3/4	1 1/2	3/4	1.61	40.9	0.90	22.9	2 1/8
110H _ 1 1/2 X 1	1 1/2	1	1.61	40.9	1.17	29.7	2 1/8
110H _ 1 1/2 X 1 1/4	1 1/2	1 1/4	2.31	58.7	1.50	38.1	2 1/8
110H _ 2 X 1/2	2	1/2	1.83	46.5	0.73	18.5	2 3/4
110H _ 2 X 3/4	2	3/4	1.83	46.5	0.94	23.9	2 3/4
110H _ 2 X 1	2	1	1.83	46.5	1.17	29.7	2 3/4
110H _ 2 X 1 1/4	2	1 1/4	1.83	46.5	1.50	38.1	2 3/4
110H _ 2 X 1 1/2	2	1 1/2	1.83	46.5	1.73	43.9	2 3/4

"D" Dimension is minimum opening. Dimensions are for reference only and subject to change without notice.

110HOB

REDUCING BUSHING SAE/MS STRAIGHT THREAD BOSS*

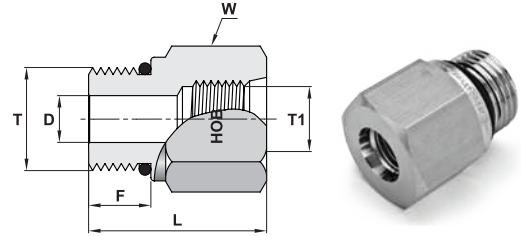

Ordering Information	T Straight Thread UN	T1 Straight Thread UN	D		L		F		W Hex. Flat	O-Ring**
	inch	inch	inch	mm	inch	mm	inch	mm	inch	
110HOB_ 9/16-18 X 7/16-20	9/16-18	7/16-20	0.28	7.1	1.12	28.4	0.36	9.1	13/16	-906
110HOB_ 3/4-16 X 7/16-20	3/4-16	7/16-20	0.24	6.0	1.30	33.0	0.44	11.2	15/16	-908
110HOB_ 3/4-16 X 9/16-18	3/4-16	9/16-18	0.42	10.7	1.19	30.2	0.44	11.2	1	-908
110HOB_ 3/4-16 X 7/8-14	3/4-16	7/8-14	0.42	10.7	1.60	40.6	0.44	11.2	1 1/2	-908
110HOB_ 7/8-14 X 9/16-18	7/8-14	9/16-18	0.50	12.7	1.10	27.9	0.50	12.7	1	-910
110HOB_ 7/8-14 X 3/4-16	7/8-14	3/4-16	0.50	12.7	1.42	36.1	0.50	12.7	1 3/16	-910
110HOB_ 1 1/16-12 X 3/4-16	1 1/16-12	3/4-16	0.65	16.5	1.27	32.3	0.59	15.0	1 1/4	-912
110HOB_ 1 5/16-12 X 1 1/16-12	1 5/16-12	1 1/16-12	0.87	22.1	1.61	40.9	0.59	15.0	1 5/8	-916
110HOB_ 1 5/8-12 X 1 5/16-12	1 5/8-12	1 5/16-12	1.09	27.7	1.98	50.3	0.59	15.0	2 1/8	-920
110HOB_ 1 7/8-12 X 1 5/16-12	1 7/8-12	1 5/16-12	1.23	31.2	1.27	32.3	0.59	15.0	2 1/8	-924

113H

HEX LONG NIPPLE

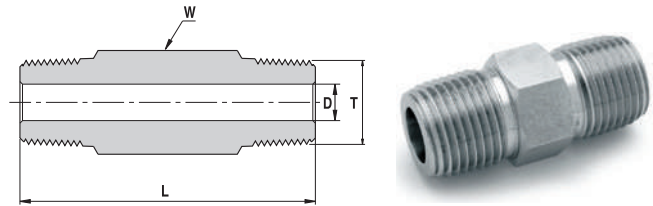

Ordering Information	T Female NPT Size	L Available Lengths (inch)						D Min. Opening		W Hex. Flat
	inch	1.50	2.00	2.50	3.00	4.00	6.00	inch	mm	inch
113H_ 1/8 X 1.5 / 2 / 2.5 / 3	1/8	✓	✓	✓	✓	-	-	0.19	4.8	7/16
113H_ 1/4 X 1.5 / 2 / 2.5 / 3 / 4	1/4	✓	✓	✓	✓	✓	-	0.28	7.1	9/16
113H_ 3/8 X 1.5 / 2 / 2.5 / 3 / 4	3/8	✓	✓	✓	✓	✓	-	0.38	9.6	11/16
113H_ 1/2 X 2 / 3 / 4	1/2	-	✓	-	✓	✓	✓	0.47	11.9	7/8
113H_ 3/4 X 2 / 3 / 4	3/4	-	✓	-	✓	✓	-	0.62	15.8	1 1/16
113H_ 1 X 3 / 4	1	-	-	-	✓	✓	-	0.88	22.4	1 3/8

*Per SAE J1926 and MS 16142.

** O-rings used are Fluorocarbon FKM 90 Durometer. Other O-ring materials are available on request.

"D" Dimension is minimum opening. Dimensions are for reference only and subject to change without notice.

116 H STREET ELBOW

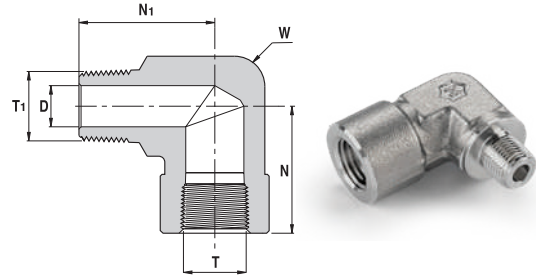

Ordering Information	T Female NPT Size	T1 Male NPT Size	N		N1		D Min. Opening		W Wrench Flat
			inch	mm	inch	mm	inch	mm	inch
116H_ 1/16 X 1/16	1/16	1/16	0.86	21.8	0.88	22.4	0.12	3.10	7/16
116H_ 1/8 X 1/16	1/8	1/16	1.04	26.4	0.87	22.1	0.12	3.10	5/8
116H_ 1/8 X 1/8	1/8	1/8	1.04	26.4	0.87	22.1	0.19	4.80	5/8
116H_ 1/4 X 1/8	1/4	1/8	1.17	29.7	1.00	25.4	0.19	4.80	11/16
116H_ 1/4 X 1/4	1/4	1/4	1.17	29.7	1.17	29.7	0.28	7.10	11/16
116H_ 3/8 X 1/4	3/8	1/4	1.42	36.1	1.26	32.0	0.28	7.10	15/16
116H_ 3/8 X 3/8	3/8	3/8	1.42	36.1	1.26	32.0	0.38	9.60	15/16
116H_ 1/2 X 1/4	1/2	1/4	1.56	39.6	1.38	35.1	0.28	7.10	1 1/8
116H_ 1/2 X 3/8	1/2	3/8	1.56	39.6	1.38	35.1	0.38	9.60	1 1/8
116H_ 1/2 X 1/2	1/2	1/2	1.56	39.6	1.56	39.6	0.47	11.9	1 1/8
116H_ 3/4 X 3/4	3/4	3/4	1.92	48.8	1.67	42.4	0.62	15.8	1 3/8
116H_ 1 X 1	1	1	1.83	46.5	1.94	49.3	0.86	21.8	1 11/16

119 H HEX REDUCING COUPLING

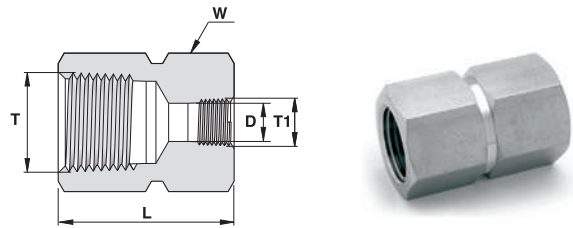

Ordering Information	T Female NPT Size	T1 Female NPT Size	L		D Min. Opening		W Hex. Flat
			inch	mm	inch	mm	inch
119H_ 1/4 X 1/8	1/4	1/8	1.22	31.0	0.31	7.8	3/4
119H_ 3/8 X 1/4	3/8	1/4	1.38	35.1	0.41	10.5	7/8
119H_ 1/2 X 1/8	1/2	1/8	1.56	39.6	0.31	7.8	1 1/16
119H_ 1/2 X 1/4	1/2	1/4	1.75	44.5	0.41	10.5	1 1/16
119H_ 1/2 X 3/8	1/2	3/8	1.78	45.2	0.56	14.2	1 1/16
119H_ 3/4 X 1/4	3/4	1/4	1.81	46.0	0.41	10.5	1 5/16
119H_ 3/4 X 1/2	3/4	1/2	2.06	52.3	0.69	17.4	1 5/16
119H_ 1 X 1/2	1	1/2	2.19	55.6	0.69	17.4	1 5/8
119H_ 1 X 3/4	1	3/4	2.25	57.2	0.90	22.9	1 5/8

"D" Dimension is minimum opening. Dimensions are for reference only and subject to change without notice.

120 H ADAPTER NPT

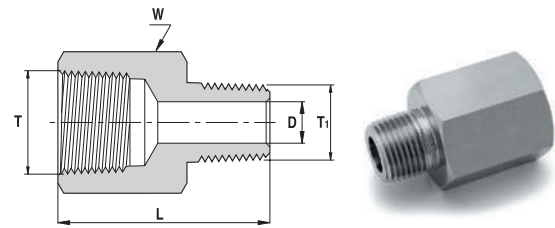

Ordering Information	T	T1	L		D		W
	Female NPT Size	Female NPT Size	Min. Opening		Hex. Flat		
	inch	inch	inch	mm	inch	mm	inch
120H _ 1/8 X 1/16	1/8	1/16	1.09	27.7	0.12	3.0	9/16
120H _ 1/8 X 1/8	1/8	1/8	1.10	27.9	0.19	4.8	9/16
120H _ 1/4 X 1/8	1/4	1/8	1.26	32.0	0.19	4.8	3/4
120H _ 1/4 X 1/4	1/4	1/4	1.40	35.6	0.28	7.1	3/4
120H _ 3/8 X 1/8	3/8	1/8	1.33	33.8	0.19	4.8	7/8
120H _ 3/8 X 1/4	3/8	1/4	1.50	38.1	0.28	7.1	7/8
120H _ 3/8 X 3/8	3/8	3/8	1.51	38.4	0.38	9.6	7/8
120H _ 1/2 X 1/8	1/2	1/8	1.58	40.1	0.19	4.8	1 1/16
120H _ 1/2 X 1/4	1/2	1/4	1.76	44.7	0.28	7.1	1 1/16
120H _ 1/2 X 3/8	1/2	3/8	1.75	44.5	0.37	9.5	1 1/16
120H _ 1/2 X 1/2	1/2	1/2	1.94	49.3	0.47	11.9	1 1/16
120H _ 3/4 X 1/4	3/4	1/4	1.85	47.0	0.28	7.1	1 5/16
120H _ 3/4 X 3/8	3/4	3/8	1.82	46.2	0.37	9.5	1 5/16
120H _ 3/4 X 1/2	3/4	1/2	2.02	51.3	0.47	11.9	1 5/16
120H _ 3/4 X 3/4	3/4	3/4	2.02	51.3	0.62	15.8	1 5/16
120H _ 1 X 1/4	1	1/4	1.96	49.8	0.28	7.1	1 5/8
120H _ 1 X 1/2	1	1/2	2.16	54.9	0.47	11.9	1 5/8
120H _ 1 X 3/4	1	3/4	2.17	55.1	0.62	15.7	1 5/8
120H _ 1 X 1	1	1	2.28	57.9	0.86	21.8	1 5/8

120 HNR ADAPTER NPT TO BSPT

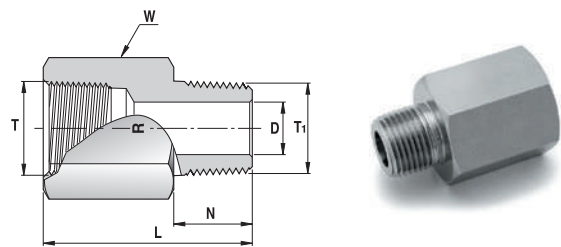

Ordering Information	T	T1	L		N		D		W
	Female NPT Size	Male BSPT ISO 7/1, BS21 Size	Min. Opening		Hex. Flat				
	inch		inch	mm	inch	mm	inch	mm	inch
120HNR _ 1/8	1/8	1/8-28	1.09	27.7	0.38	9.7	0.19	4.8	9/16
120HNR _ 1/4	1/4	1/4-19	1.42	36.1	0.56	14.2	0.28	7.1	3/4
120HNR _ 3/8	3/8	3/8-19	1.50	38.1	0.56	14.2	0.38	9.6	7/8
120HNR _ 1/2	1/2	1/2-14	1.94	49.3	0.75	19.0	0.47	11.9	1 1/16
120HNR _ 3/4	3/4	3/4-14	2.02	51.3	0.75	19.0	0.62	15.8	1 5/16
120HNR _ 1	1	1-11	2.30	58.4	0.94	23.9	0.88	22.4	1 5/8

"D" Dimension is minimum opening. Dimensions are for reference only and subject to change without notice.

120 HNG ADAPTER NPT TO BSPP

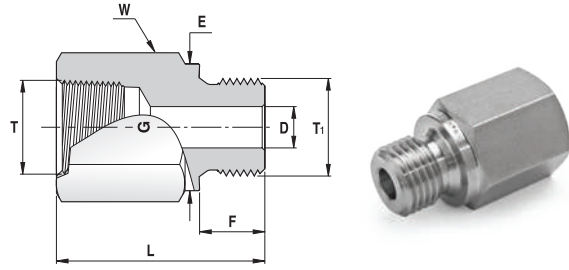

Ordering Information	T	T1	L		F		E Dia.		D		W
	Female NPT Size	Male BSPP ISO 228/1, BS 2779	inch	mm	inch	mm	inch	mm	inch	mm	Hex. Flat
120HNG_ 1/8	1/8	1/8-28	0.99	25.1	0.28	7.1	0.54	13.8	0.16	4.1	9/16
120HNG_ 1/4	1/4	1/4-19	1.32	33.5	0.44	11.2	0.70	18.0	0.23	5.8	3/4
120HNG_ 3/8	3/8	3/8-19	1.41	35.8	0.44	11.2	0.85	21.8	0.31	7.9	7/8
120HNG_ 1/2	1/2	1/2-14	1.74	44.2	0.56	14.2	1.02	26.0	0.47	11.9	1 1/16
120HNG_ 3/4	3/4	3/4-14	1.89	48.0	0.62	15.7	1.26	32.0	0.62	15.7	1 5/16
120HNG_ 1	1	1-11	2.10	53.3	0.72	18.3	1.53	39.0	0.78	19.8	1 5/8

Gaskets for BSPP Parallel Threads Sealing, see page 85

120HNOB ADAPTER NPT TO SAE/MS STRAIGHT THREAD BOSS*

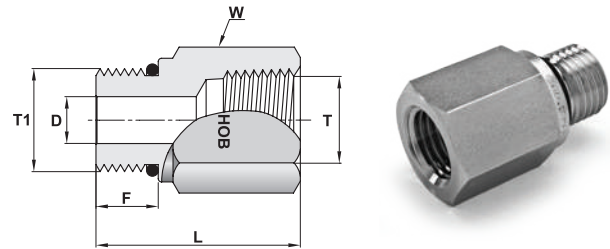

Ordering Information	T	T1	D		L		F		W	O-Ring**
	Female NPT Size	Straight Thread UN	inch	mm	inch	mm	inch	mm	Hex. Flat	
120HNOB_ 1/4 X 7/16-20	1/4	7/16-20	0.20	5.1	1.32	33.5	0.36	9.1	3/4	-904
120HNOB_ 3/8 X 9/16-18	3/8	9/16-18	0.28	7.1	1.39	35.3	0.39	9.9	15/16	-906
120HNOB_ 1/2 X 3/4-16	1/2	3/4-16	0.42	10.7	1.76	44.7	0.44	11.2	1 1/16	-908
120HNOB_ 3/4 X 1 1/16-12	3/4	1 1/16-12	0.66	16.7	1.99	50.5	0.59	15.0	1 3/8	-912
120HNOB_ 1 X 1 5/16-12	1	1 5/16-12	0.88	22.3	2.12	53.8	0.59	15.0	1 5/8	-916

120 HRN ADAPTER BSPT TO NPT

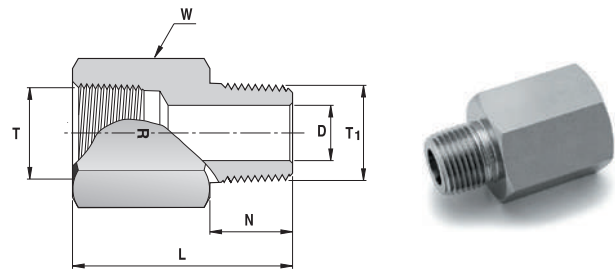

Ordering Information	T	T	L		N		D		W
	Female BSPT ISO 7/1, BS21	Female NPT Size	inch	mm	inch	mm	inch	mm	Hex. Flat
120HRN_ 1/4	1/4-19	1/4	1.43	36.3	0.56	14.2	0.28	7.1	3/4
120HRN_ 3/8	3/8-19	3/8	1.51	38.4	0.56	14.2	0.38	9.6	7/8
120HRN_ 1/2	1/2-14	1/2	1.96	49.8	0.75	19.1	0.47	11.9	1 1/16

*Per SAE J1926 and MS 16142.

**O-rings used are Fluorocarbon FKM 90 Durometer. Other O-ring materials available on request.

“D” Dimension is minimum opening. Dimensions are for reference only and subject to change without notice.

120 HGN GAUGE ADAPTER BSPP TO NPT

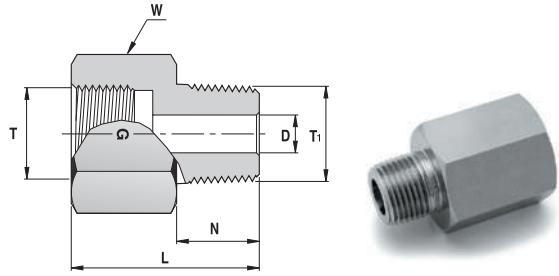

Ordering Information	T Female BSPP ISO 228/1, BS 2779 Size	T Female NPT Size	L		N		D Min. Opening		W Hex. Flat
			inch	mm	inch	mm	inch	mm	
120HGN_ 1/4	1/4-19	1/4	1.19	30.2	0.56	14.2	0.22	5.6	3/4
120HGN_ 3/8	3/8-19	3/8	1.27	32.3	0.56	14.2	0.26	6.6	15/16
120HGN_ 1/2	1/2-14	1/2	1.65	41.9	0.75	19.0	0.28	7.1	1 1/16

Gaskets for BSPP Parallel Threads Sealing, see page 85

121 H PIPE PLUG NPT

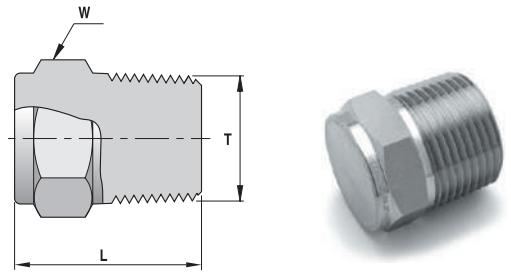

Ordering Information	T Male NPT Size	L		W Hex. Flat
	inch	inch	mm	inch
121H_ 1/16	1/16	0.75	19.0	5/16
121H_ 1/8	1/8	0.75	19.0	7/16
121H_ 1/4	1/4	0.96	24.4	9/16
121H_ 3/8	3/8	0.99	25.2	11/16
121H_ 1/2	1/2	1.21	30.7	7/8
121H_ 3/4	3/4	1.21	30.7	1 1/16
121H_ 1	1	1.50	38.1	1 3/8

121HOB HEX HEAD PLUG SAE/MS STRAIGHT THREAD BOSS*

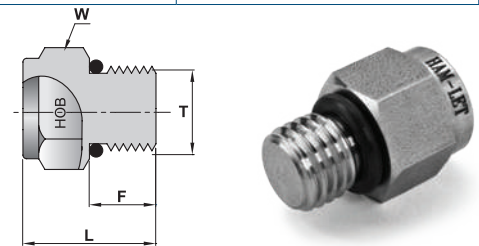

Ordering Information	T Straight Thread UN	L		F		W Hex. Flat	O-Ring**
	inch	inch	mm	inch	mm	inch	
121HOB_ 5/16-24	5/16-24	0.70	17.8	0.30	7.6	7/16	-902
121HOB_ 7/16-20	7/16-20	0.76	19.3	0.36	9.1	9/16	-904
121HOB_ 9/16-18	9/16-18	0.82	20.8	0.39	9.9	11/16	-906
121HOB_ 3/4-16	3/4-16	0.89	22.6	0.44	11.2	7/8	-908
121HOB_ 1 1/16-12	1 1/16-12	1.12	28.4	0.59	15.0	1 1/4	-912
121HOB_ 1 5/16-12	1 5/16-12	1.18	30.0	0.59	15.0	1 1/2	-916

*Per SAE J1926 and MS 16142.

**O-rings used are Fluorocarbon FKM 90 Durometer. Other O-ring materials available on request.

“D” Dimension is minimum opening. Dimensions are for reference only and subject to change without notice.

122 H HEX NIPPLE

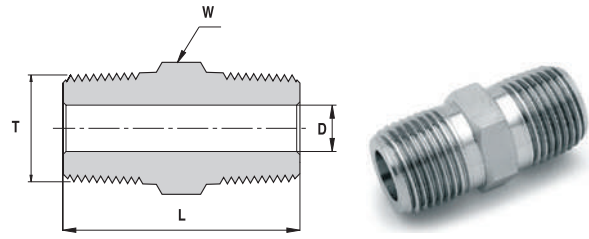

Ordering Information	T Male NPT Size	L		D Min. Opening		W Hex. Flat
	inch	inch	mm	inch	mm	inch
122H_1/16	1/16	1.01	25.7	0.12	3.0	5/16
122H_1/8	1/8	1.01	25.7	0.19	4.8	7/16
122H_1/4	1/4	1.40	35.6	0.28	7.1	9/16
122H_3/8	3/8	1.43	36.3	0.38	9.6	11/16
122H_1/2	1/2	1.84	46.7	0.47	11.9	7/8
122H_3/4	3/4	1.84	46.7	0.62	15.8	1 1/16
122H_1	1	2.32	58.9	0.87	22.1	1 3/8

122 HNR HEX NIPPLE NPT TO BSPT

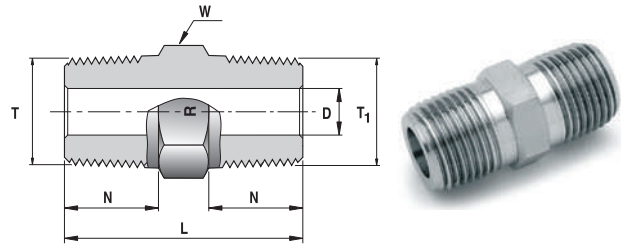

Ordering Information	T Male NPT Size	T1 Male BSPT ISO 7/1, BS21 Size	L		N		D Min. Opening		W Hex. Flat
	inch		inch	mm	inch	mm	inch	mm	inch
122HNR_1/8	1/8	1/8-28	1.01	25.6	0.38	9.7	0.19	4.8	7/16
122HNR_1/4	1/4	1/4-19	1.40	35.6	0.56	14.2	0.28	7.1	9/16
122HNR_3/8	3/8	3/8-19	1.43	36.3	0.56	14.2	0.38	9.6	11/16
122HNR_1/2	1/2	1/2-14	1.84	46.7	0.75	19.0	0.47	11.9	7/8
122HNR_3/4	3/4	3/4-14	1.84	46.7	0.75	19.0	0.62	15.8	1 1/16
122HNR_1	1	1-11	2.32	58.9	0.94	23.9	0.87	22.1	1 3/8

“D” Dimension is minimum opening. Dimensions are for reference only and subject to change without notice.

122 HNG HEX NIPPLE NPT TO BSPP

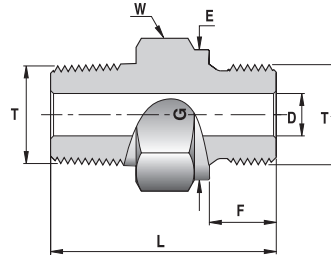

Ordering Information	T Male NPT Size	T1 Male BSPP ISO 228/1, BS 2779	L		F		E		D Min. Opening		W Hex. Flat
	inch		inch	mm	inch	mm	inch	mm	inch	mm	inch
122HNG _ 1/8	1/8	1/8-28	1.07	27.2	0.28	7.1	0.54	13.8	0.16	4.1	9/16
122HNG _ 1/4	1/4	1/4-19	1.44	36.6	0.44	11.2	0.71	18.0	0.23	5.8	3/4
122HNG _ 3/8	3/8	3/8-19	1.47	37.3	0.44	11.2	0.85	21.8	0.31	7.9	7/8
122HNG _ 1/2	1/2	1/2-14	1.78	45.2	0.56	14.2	1.02	26.0	0.47	11.9	1 1/16
122HNG _ 3/4	3/4	3/4-14	1.95	49.5	0.62	15.7	1.26	32.0	0.62	15.8	1 5/16
122HNG _ 1	1	1-11	2.26	57.4	0.72	18.3	1.53	39.0	0.78	19.8	1 5/8

Gaskets for BSPP Parallel Threads Sealing, see page 85

122HNOB HEX NIPPLE NPT TO SAE/MS STRAIGHT THREAD BOSS*

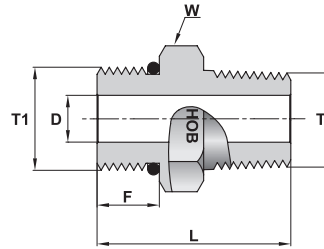

Ordering Information	T Male NPT Size	T1 Straight Thread UN	D		L		F		W Hex. Flat	O-Ring**
	inch		inch	mm	inch	mm	inch	mm	inch	
122HNOB _ 1/4 X 7/16-20	1/4	7/16-20	0.20	5.1	1.20	30.5	0.36	9.1	9/16	-904
122HNOB _ 3/8 X 9/16-18	3/8	9/16-18	0.28	7.1	1.26	32.0	0.39	9.9	11/16	-906
122HNOB _ 1/2 X 3/4-16	1/2	3/4-16	0.42	10.7	1.53	38.9	0.44	11.2	7/8	-908
122HNOB _ 3/4 X 1 1/16-12	3/4	1 1/16-12	0.62	15.7	1.75	44.4	0.59	15.0	1 1/4	-912
122HNOB _ 1 X 1 5/16-12	1	1 5/16-12	0.88	22.4	2.00	50.8	0.59	15.0	1 1/2	-916

122HCN CLOSE NIPPLE

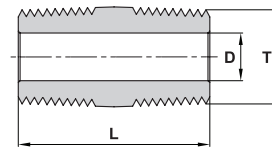

Ordering Information	T Male NPT Size	D		L	
	inch	inch	mm	inch	mm
122HCN _ 1/8	1/8	0.19	4.8	0.75	19.1
122HCN _ 1/4	1/4	0.28	7.1	1.12	28.4
122HCN _ 3/8	3/8	0.38	9.6	1.12	28.4
122HCN _ 1/2	1/2	0.47	11.9	1.50	38.1
122HCN _ 3/4	3/4	0.62	15.7	1.50	38.1
122HCN _ 1	1	0.88	22.4	1.88	47.8

*Per SAE J1926 and MS 16142.

** O-rings used are Fluorocarbon FKM 90 Durometer. Other O-ring materials available on request.

"D" Dimension is minimum opening. Dimensions are for reference only and subject to change without notice.

123 H

REDUCING NIPPLE

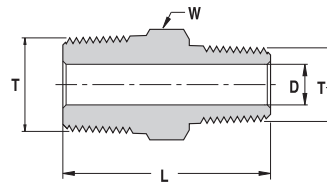

Ordering Information	T	T1	L		D		W
	Male NPT Size	Male NPT Size	Min. Opening		Hex. Flat		
	inch		inch	mm	inch	mm	inch
123H_ 1/8 X 1/16	1/8	1/16	1.01	25.7	0.12	3.0	7/16
123H_ 1/4 X 1/8	1/4	1/8	1.22	31.0	0.19	4.8	9/16
123H_ 3/8 X 1/8	3/8	1/8	1.25	31.8	0.19	4.8	11/16
123H_ 3/8 X 1/4	3/8	1/4	1.43	36.3	0.28	7.1	11/16
123H_ 1/2 X 1/8	1/2	1/8	1.47	37.3	0.19	4.8	7/8
123H_ 1/2 X 1/4	1/2	1/4	1.65	41.9	0.28	7.1	7/8
123H_ 1/2 X 3/8	1/2	3/8	1.65	41.9	0.38	9.6	7/8
123H_ 3/4 X 1/4	3/4	1/4	1.65	41.9	0.28	7.1	1 1/16
123H_ 3/4 X 1/2	3/4	1/2	1.84	46.7	0.47	11.9	1 1/16
123H_ 1 X 1/2	1	1/2	2.13	54.1	0.47	11.9	1 3/8
123H_ 1 X 3/4	1	3/4	2.13	54.1	0.62	15.8	1 3/8

3600 H

BRANCH TEE

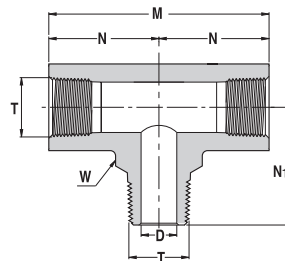

Ordering Information	T	M		N		N1		D		W
	Male & Female NPT	inch	mm	inch	mm	inch	mm	inch	mm	
3600H_ 1/8	1/8	2.08	52.8	1.04	26.4	0.87	22.1	0.19	4.8	5/8
3600H_ 1/4	1/4	2.34	59.4	1.17	29.7	1.17	29.7	0.28	7.1	13/16
3600H_ 3/8	3/8	2.84	72.1	1.42	36.1	1.26	32.0	0.38	9.6	15/16
3600H_ 1/2	1/2	3.12	79.2	1.56	39.6	1.56	39.6	0.47	11.9	1 1/8

"D" Dimension is minimum opening. Dimensions are for reference only and subject to change without notice.

3750 H STREET TEE

Male & Female NPT

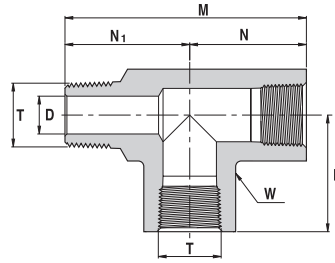

Ordering Information	T Male & Female NPT		M		N		N1		D Min. Opening		W Wrench Flat
	inch	inch	mm	mm	inch	mm	inch	mm	inch	mm	inch
3750H_ 1/8	1/8	1.91	48.5	1.04	26.4	0.87	22.1	0.19	4.8	5/8	
3750H_ 1/4	1/4	2.34	59.4	1.17	29.7	1.17	29.7	0.28	7.1	13/16	
3750H_ 3/8	3/8	2.68	68.1	1.42	36.1	1.26	32.0	0.38	9.6	15/16	
3750H_ 1/2	1/2	3.12	79.2	1.56	39.6	1.56	39.6	0.47	11.9	1 1/8	

130 HM MALE TO HOSE CONNECTOR

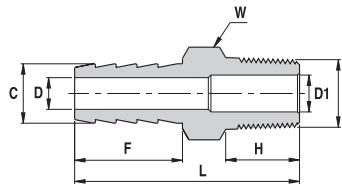

Ordering Information	Hose I.D.	T Male NPT Size		C		D		D1		F		H		L		W Hex. Flat
		inch	inch	mm	mm	inch	mm	inch	mm	inch	mm	inch	mm	inch	mm	inch
130HM_ 1/8 X 1/8	1/8	1/8	0.15	3.80	0.08	2.0	0.19	4.80	0.40	10.2	0.38	9.70	1.08	27.4	7/16	
130HM_ 1/8 X 1/4	1/8	1/4	0.15	3.80	0.08	2.0	0.28	7.10	0.40	10.2	0.56	14.2	1.26	32.0	9/16	
130HM_ 3/16 X 1/8	3/16	1/8	0.23	5.84	0.12	3.0	0.12	3.00	0.59	15.0	0.38	9.70	1.27	32.3	7/16	
130HM_ 3/16 X 1/4	3/16	1/4	0.23	5.84	0.12	3.0	0.28	7.10	0.59	15.0	0.56	14.2	1.45	36.8	9/16	
130HM_ 1/4 X 1/8	1/4	1/8	0.30	7.62	0.19	4.8	0.19	4.80	0.79	20.1	0.38	9.70	1.47	37.3	7/16	
130HM_ 1/4 X 1/4	1/4	1/4	0.30	7.62	0.19	4.8	0.19	4.80	0.79	20.1	0.56	14.2	1.65	41.9	9/16	
130HM_ 1/4 X 3/8	1/4	3/8	0.30	7.62	0.19	4.8	0.19	4.80	0.79	20.1	0.56	14.2	1.66	42.2	11/16	
130HM_ 1/4 X 1/2	1/4	1/2	0.30	7.62	0.19	4.8	0.47	11.9	0.79	20.1	0.75	19.0	1.85	47.0	7/8	
130HM_ 5/16 X 1/8	5/16	1/8	0.38	9.65	0.19	4.8	0.19	4.80	0.87	22.1	0.38	9.70	1.55	39.4	7/16	
130HM_ 5/16 X 1/4	5/16	1/4	0.38	9.65	0.19	4.8	0.19	4.80	0.87	22.1	0.56	14.2	1.73	43.9	9/16	
130HM_ 5/16 X 3/8	5/16	3/8	0.38	9.65	0.19	4.8	0.37	9.50	0.87	22.1	0.56	14.2	1.74	44.2	11/16	
130HM_ 5/16 X 1/2	5/16	1/2	0.38	9.65	0.19	4.8	0.47	11.9	0.87	22.1	0.75	19.0	1.96	49.8	7/8	
130HM_ 3/8 X 1/4	3/8	1/4	0.45	11.43	0.30	7.6	0.30	7.60	0.87	22.1	0.56	14.2	1.73	43.9	9/16	
130HM_ 3/8 X 3/8	3/8	3/8	0.45	11.43	0.30	7.6	0.30	7.60	0.87	22.1	0.56	14.2	1.74	44.2	11/16	
130HM_ 3/8 X 1/2	3/8	1/2	0.45	11.43	0.30	7.6	0.30	7.60	0.87	22.1	0.75	19.0	1.96	49.8	7/8	
130HM_ 1/2 X 1/4	1/2	1/4	0.60	15.24	0.37	9.5	0.28	7.10	0.94	23.8	0.56	14.2	1.80	45.7	11/16	
130HM_ 1/2 X 3/8	1/2	3/8	0.60	15.24	0.37	9.5	0.37	9.50	0.94	23.8	0.56	14.2	1.81	46.0	11/16	
130HM_ 1/2 X 1/2	1/2	1/2	0.60	15.24	0.37	9.5	0.37	9.50	0.94	23.8	0.75	19.0	2.03	51.6	7/8	
130HM_ 5/8 X 1/2	5/8	1/2	0.75	19.10	0.47	11.9	0.47	11.9	0.98	24.9	0.75	19.0	2.07	52.6	1 1/16	
130HM_ 5/8 X 3/4	5/8	3/4	0.75	19.10	0.50	12.7	0.63	16.0	0.98	24.9	0.75	19.0	2.07	52.6	1 1/16	
130HM_ 3/4 X 1/2	3/4	1/2	0.90	22.86	0.63	16.0	0.47	11.9	1.05	26.7	0.75	19.0	2.14	54.4	1 1/16	
130HM_ 3/4 X 3/4	3/4	3/4	0.90	22.86	0.63	16.0	0.63	16.0	1.05	26.7	0.75	19.0	2.14	54.4	1 1/16	
130HM_ 3/4 X 1	3/4	1	0.90	22.86	0.63	16.0	0.88	22.4	1.05	26.7	0.94	23.9	2.43	61.7	1 3/8	
130HM_ 1 X 3/4	1	3/4	1.2	30.48	0.88	22.4	0.63	16.0	1.19	30.2	0.75	19.0	2.38	60.5	1 3/8	
130HM_ 1 X 1	1	1	1.2	30.48	0.88	22.4	0.88	22.4	1.19	30.2	0.94	23.9	2.57	65.3	1 3/8	

"D" Dimension is minimum opening. Dimensions are for reference only and subject to change without notice.

130 HF FEMALE HOSE CONNECTOR

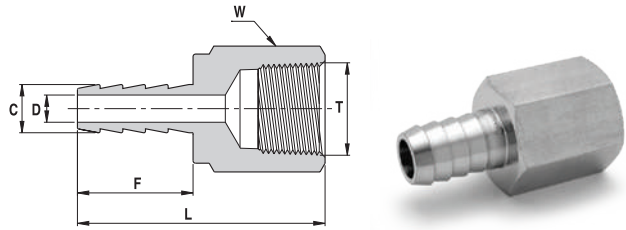

Ordering Information	Hose I.D.	T NPT Size	C		D		F		L		W Hex. Flat
		inch	inch	mm	inch	mm	inch	mm	inch	mm	inch
130HF _ 1/8 X 1/8	1/8	1/8	0.15	3.80	0.08	2.00	0.40	10.2	1.11	28.2	9/16
130HF _ 1/8 X 1/4	1/8	1/4	0.15	3.80	0.08	2.00	0.40	10.2	1.26	32.0	3/4
130HF _ 3/16 X 1/8	3/16	1/8	0.23	5.84	0.12	3.00	0.59	15.0	1.29	32.8	9/16
130HF _ 3/16 X 1/4	3/16	1/4	0.23	5.84	0.12	3.00	0.59	15.0	1.44	36.6	3/4
130HF _ 1/4 X 1/8	1/4	1/8	0.30	7.62	0.19	4.80	0.79	20.1	1.47	37.3	9/16
130HF _ 1/4 X 1/4	1/4	1/4	0.30	7.62	0.19	4.80	0.79	20.1	1.64	41.7	3/4
130HF _ 1/4 X 3/8	1/4	3/8	0.30	7.62	0.19	4.80	0.79	20.1	1.71	43.4	7/8
130HF _ 5/16 X 1/4	5/16	1/4	0.38	9.65	0.19	4.80	0.87	22.1	1.73	43.9	3/4
130HF _ 5/16 X 3/8	5/16	3/8	0.38	9.65	0.19	4.80	0.87	22.1	1.82	46.2	7/8
130HF _ 3/8 X 1/4	3/8	1/4	0.45	11.43	0.30	7.60	0.87	22.1	1.69	42.9	3/4
130HF _ 3/8 X 3/8	3/8	3/8	0.45	11.43	0.30	7.60	0.87	22.1	1.78	45.2	7/8
130HF _ 3/8 X 1/2	3/8	1/2	0.45	11.43	0.30	7.60	0.87	22.1	2.03	51.6	1 1/16
130HF _ 1/2 X 1/2	1/2	1/2	0.60	15.24	0.38	9.70	0.94	23.9	2.13	54.1	1 1/16

"D" Dimension is minimum opening.

130 LT TUBE TO HOSE CONNECTOR

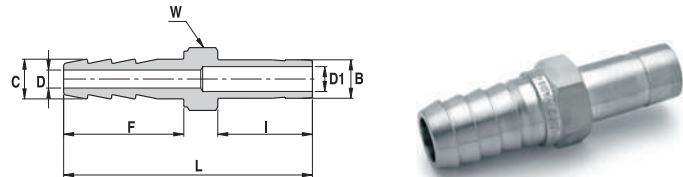

Ordering Information	Hose I.D.	B Tube Size	C		D		D1		F		I		L		W Hex. Flat
		inch	inch	mm	inch	mm	inch	mm	inch	mm	inch	mm	inch	mm	inch
130LT _ 1/8 X 1/8	1/8	1/8	0.15	3.80	0.08	2.00	0.08	2.00	0.40	10.2	0.53	13.5	1.35	34.3	5/16
130LT _ 1/8 X 1/4	1/8	1/4	0.15	3.80	0.08	2.00	0.17	4.20	0.40	10.2	0.62	15.7	1.44	36.6	3/8
130LT _ 1/4 X 1/4	1/4	1/4	0.30	7.62	0.19	4.80	0.17	4.20	0.79	20.1	0.62	15.7	1.83	46.5	7/16
130LT _ 1/4 X 3/8	1/4	3/8	0.30	7.62	0.19	4.80	0.27	6.85	0.79	20.1	0.69	17.5	1.90	48.3	7/16
130LT _ 1/4 X 6 MM	1/4	6mm	0.30	7.62	0.19	4.80	0.16	4.00	0.79	20.1	0.62	15.7	1.86	47.2	7/16
130LT _ 5/16 X 1/4	5/16	1/4	0.37	9.40	0.19	4.80	0.17	4.20	0.87	22.1	0.62	15.7	1.91	48.5	7/16
130LT _ 3/8 X 3/8	3/8	3/8	0.45	11.43	0.30	7.60	0.27	6.85	0.87	22.1	0.69	17.5	1.98	50.3	9/16
130LT _ 3/8 X 1/2	3/8	1/2	0.45	11.43	0.30	7.60	0.37	9.40	0.87	22.1	0.91	23.1	2.20	55.9	5/8
130LT _ 1/2 X 3/8	1/2	3/8	0.60	15.24	0.38	9.70	0.27	6.85	0.94	23.9	0.69	17.5	2.05	52.1	11/16
130LT _ 1/2 X 1/2	1/2	1/2	0.60	15.24	0.38	9.70	0.37	9.40	0.94	23.9	0.91	23.1	2.27	57.7	11/16
130LT _ 3/4 X 3/4	3/4	3/4	0.90	22.86	0.63	16.0	0.59	15.0	1.05	26.7	0.97	24.6	2.44	62.0	1 1/16

"D" Dimension is minimum opening. Dimensions are for reference only and subject to change without notice.



This document is proprietary to UCT and may not be copied, duplicated or used without the permission of UCT Fluid Solutions. UCT reserves the right to make changes to any portion of this document at any time without notice. The information furnished by UCT in this document is believed to be accurate and reliable. However, UCT assumes no responsibility for its use or for errors or omissions. All trademarks, models, names and logos in this catalogue are subject to the rights of UCT, unless indicated otherwise.

Precision Instrument Pipe Fittings | June 2023